

IMA

CONCEPT

IMA CONCEPT

Catalog 2026

www.imaconcept.ro

Expert Water®
Keman



www.imaconcept.ro
office@imaconcept.ro

Descrierea sistemului:

Filtrele mecanice sunt cele mai simple filtre care se pot folosi in tratarea apei reci si au un rol foarte important in protejarea echipamentelor ce le urmeaza in instalatii, protejandu-le de sedimentele din apa.

Disponibile in doua variante de lungime 10" si 20" ele pot fi folosite cu orice fel de cartus de polipropilena 1, 5, 10, 20 microni sau cartuse de carbune activ bloc / granular acolo unde aplicatiile o solicita.

Filtrele se livreaza complet echipate cu cheie - suport de perete si cartus de polipropilena.

De asemenea ambele variante de filtru sunt proiectate cu aerisitor manual.

Vasele filtrelor sunt transparente pentru a putea observa mai usor incarcarea lor cu sediment.

Orice cartus de sediment este recomandat sa se inlocuiasca la maximum 6 luni din considerente bacteriologice chiar daca nu s-a incarcat!

- * usor de conectat prin filetul interior de 1"
- * cartus usor schimbabil
- * ideal pentru intreaga locatie sau diferite echipamente ce necesita filtru
- * nu necesita electricitate sau drenaj
- * cu aplicabilitate pentru apa potabila
- * pierdere de presiune mica in exploatare (pentru cartus curat)



Filtrele se pot folosi atat in aplicatii industriale
cat si in aplicatii casnice unde se impune
instalarea unui filtru de sedimente



Articol	Debit max (l/h)	Limite presiune (bar)	Conexiuni intrare-iesire	Finete filtrare (microni)	Limite temp (°C)	Dimensiuni (lungime x diametru)
Filtru FD 10	3500	1 - 8	1"	20 - 10 - 5 - 1	4-50	30 x 14
<i>Incluse</i> -Cheie -Suport perete -Cartus 1,5,10 sau 20 μ						
Filtru FD 20	5000	1 - 8	1"	20 - 10 - 5 - 1	4-50	59 X 14
<i>Incluse</i> -Cheie -Suport perete -Cartus 1,5,10 sau 20 μ						

Filtre Centrifugale

Filtrele centrifugale retin particulele de nisip, sediment, rugina din apa protejand sistemele ce urmeaza pe instalatie.

Descrierea sistemului :

Filtrele centrifugale sunt construite integral din materiale sintetice de cea mai buna calitate putandu-se folosi pentru apa potabila.

Vana CENTRIFUGALA schimba cursul apei in filtru imprimand forta centrifuga fortand particulele mari sa ramana in parte inferioara a vasului, in functie de dimensiunea de filtrare a mansonului.

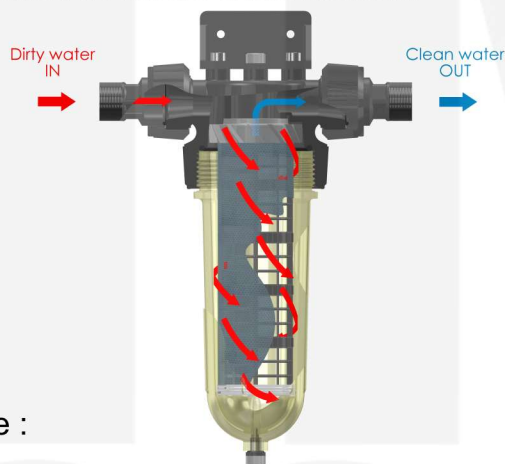

Avantaje :

- debit de functionare mare si constant
- pierdere de presiune mica
- pre filtrare centrifugala cu efect de hidrocyclon
- posibilitatea de purjare a sedimentului acumulat prin robinetul de purjare din partea inferioara
- control permanent al incarcarii cu sediment prin vasul transparent.



*Variante disponibile cu mansone filtrante 5-20-100 microni - schimbabile
150 microni - lavabile

*Modelul TE permite umplerea filtrului cu Carbune Activ pentru tratarea apei.





Articol	Debit max (mc/h)	Limite presiune (bar)	Conexiuni intrare-iesire	Finete filtrare (microni)	Limite temp (°C)	Dimensiuni (lungime x diametru) (cm)
Filtru NW 25 <i>Incluse</i> -Robinet Purjare -Cheie -Manson 25µ	5.5	2-10	1"	20 Suporta manson 5-20-100-150 microni	4-50	15x37.7
Filtru NW 32 <i>Incluse</i> -Robinet Purjare -Cheie -Manson 25µ	6500	2-10	1 1/4"	20 Suporta manson 5-20-100-150 microni	4-50	15x56
Filtru NW 32 CARBUNE ACTIV <i>Incluse</i> -Cheie -Stoc carbune activ	0.5 NOU ! Debit pt umplere cu 1.70 l CARBUNE ACTIV GRANULAR	2-10	1 1/4"	80	4-50	15x56
Filtru NW 500 <i>Incluse</i> -Robinet Purjare -Manometre IN-OUT -Manson 25µ	20	2-10	2"	20 Suporta manson 5-20-100-150 microni	4-50	19x77 distanta intre conectori = 36 cm
Filtru NW 650 <i>Incluse</i> -Robinet Purjare -Manometre IN-OUT -Manson 25µ	25	2-10	2 1/2"	20 Suporta manson 5-20-100-150 microni	4-50	19x77 distanta intre conectori = 30 cm
Filtru NW 800 <i>Incluse</i> -Robinet Purjare -Manometre IN-OUT -Manson 25µ	30	2-10	3"	20 Suporta manson 5-20-100-150 microni	4-50	19x77 distanta intre conectori = 32 cm



Articol	Finete de filtrare (microni)	Dimensiuni (lungime x diametru) (cm)
CARTUS BigBlue 10" 1-5-10-20 Microni	1-5-10-20	25x11
CARTUS BigBlue 20" 1-5-10-20 Microni	1-5-10-20	51x11
CARTUS PP 10" SLIM 1-5-10-20 Microni	1-5-10-20	25x6
CARTUS PP 20" SLIM 1-5-10-20 Microni	1-5-10-20	51x6
SET 5 MANSON FILTRU NW 25 5-10-20 Microni	5-10-20	-
SET 5 MASON FILTRU NW 25 150 MICRONI - Lavabil	150	-
SET 5 MASON FILTRU NW 32 5-10-20 Microni	5-10-20	-
SET 5 MASON FILTRU NW 32 150 Microni Lavabil	150	-
SET 5 MANSON FILTRU NW 50-65-80 5-10-20 Microni	5-10-20	-
SET 5 MANSON FILTRU NW 50-65-80 150 Microni Lavabil	150	-

IMA CONCEPT

...pentru ca apa inseamna viata

EWF CA ZE 10-180 Expert Water®

Filtre AUTOMATE cu Carbune activ / Zeolit-Turbidex
Vana CLACK SUA TC - Regenerare la timp

Descrierea sistemului :

Filtrele AUTOMATE Expert Water, in functie de mediul filtrant continut, opresc mare parte din sedimentele din apa, nisipul, reduc gustul, culoarea si mirosul neplacut din apa, retin clorul si substantele volatile.

Marele avantaj al lor este ca **nu au consumabile** si se curata singure eliminand la drenaj ceea ce au retinut in procesul de filtrare, deci nu mai este nevoie de operatii de mentenanta dese (exceptand reviziile anuale).

Tot procesul este asistat de **un calculator** care face posibila regenerarea sistemului la un numar de zile setat de utilizator si la o ora aleasa.

Mediul filtrant se inlocuieste ca operatie de service **la 3-8 ani**, functie de calitatea apei brute in afara de cazul in care exista clor unde inlocuirea carbonului activ se poate face mai des (functie de continutul de clor din apa).

Sistemele de filtrare sunt echipate cu **automatizare de control CLACK SUA** (una din cele mai mari companii de profil din lume) cu o fiabilitate foarte mare.

Sistemele pot contine (unul sau ambele) medii filtrante

ZEOLIT cu functie de Hiperfiltrare - Turbidex

Un zeolit de cea mai inalta calitate care are **capacitatea de a retine suspensiile solide** prin sedimentare, floculare, absorbtie fizica, absorbtie electrostatica si schimb de ioni pana la 5 microni inlocuirea lui se face intre 4 - 10 ani in functie de calitatea apei.

Turbidex se diferentiaza de alte medii filtrante pentru sediment prin:

- Debite mari de functionare (20pm/FT2);
- Regenerari mai rare decat ale filtrelor cu nisip sau multimedia deci economie de apa;
- Greutate mai mica cu 50% - usor de transportat.

CARBUNE ACTIV - este un produs care nu conține legaturi periculoase de carbon, cu o structură poroasă și o suprafață internă foarte mare. Structura chimică a carbonului activ poate fi definită ca o formă brută de grafit, cu o structură amorfă aleatorie, care este foarte poroasă pe o gamă de dimensiuni ale porilor, de la cavități vizibile și de la goluri la cele de dimensiuni moleculare. Tratamentul cu carbon activ este bazat în principal pe fenomenul cunoscut sub numele de adsorbție, în care moleculele unui lichid sau gaz aderă la o suprafață exterioară sau internă a unei substanțe solide. Carbonul activ are o suprafață internă foarte mare (până la 1500 m² / g), ceea ce îl face foarte potrivit pentru adsorbție.

Carbonele activ **retine deci clorul, reduce oxidabilitatea, corectează gustul si mirosul apei cat si culoarea** - in functie de compozitia chimica a apei.



Clack



Filtrele AUTOMATE se pot folosi atat in **aplicatii industriale** cat si in **aplicatii casnice** unde se impune instalarea unui filtru pentru reducerea sedimentelor, eliminare clor, miros, gust, **reducere oxidabilitate inclusiv pentru aplicatii de apa potabila**

www.imaconcept.ro

office@imaconcept.ro

Filtre AUTOMATE cu Carbune activ / Zeolit-Turbidex
Vana CLACK SUA TC - Regenerare la timp



Date tehnice Sisteme echipate cu VANA CLACK TC	Debit	Conexiuni intrare- iesire	Presiune (min/max)	Temp max	Dimensiuni
	Zeolit(Turbidex) / Carbune Activ / Zeolit+Carbune				Tanc+Vana
Model	(mc / h)	(inch)	(bar)	(°C)	(LxIx h)(cm)
EWF 10	0.8	1	2.5 - 7.5	49	17 x 80
EWF 15	1.3	1	2.5 - 7.5	49	18 x 108
EWF 20	1.7	1	2.5 - 7.5	49	22 x 108
EWF 25	1.9	1	2.5 - 7.5	49	23 x 108
EWF 35	2	1	2.5 - 7.5	49	31 x 138
EWF 50	2.9	1	2.5 - 7.5	49	31 x 138
EWF 75	3.5	1	2.5 - 7.5	49	36 x 165
EWF 100	4.4	1	2.5 - 7.5	49	36 x 165
EWF 120	5.4	1	2.5 - 7.5	49	41 x 186
EWF 140	6	1.25"	2.5 - 7.5	49	41 x 186
EWF 160	6.5	1.25"	2.5 - 7.5	49	46 x 186

Posibila orice configuratie de orice marime. Pentru altele decat cele din prezenta lista va rugam sa ne contactati
Preturile de mai sus nu includ by pass

IMA CONCEPT

...pentru ca apa inseamna viata

EWS 10-160 Expert Water®

Dedurizatoare Automate-Volumetrice cu Vana CLACK SUA CI / EI

Dedurizatoarele Expert Water retin Calcarul din apa reducand valoarea duritatii apei pana la 0 - 2 grade germane - functie de calitatea apei de intrare. Aceasta duritate se poate regla prin montarea suplimentara a unui robinet de by-pass.

Apa dura duce la:

- pete pe robineti, cabina de dus, vesela, pahare
- consum mare de energie a centralei termice din cauza acoperirii rezistentei cu calcar
- deteriorarea obiectelor sanitare si curatenia greoaie
- aspirarea rufelor si degradarea culorilor
- infundarea tevilor, instalatiilor si a robinetilor
- depuneri de piatra in boiler, masini de spalat
- formarea de pietre la rinichi

Avantaje tehnico - economice

- Design modern si compact
- Functionare automata
- Regenerare dupa Volum consumat de apa la ora aleasa de utilizator tinand cont de saturatia rasilii
- Utilizare inclusiv in industria alimentara
- Afisaj electronic
- Pierdere mica de presiune in functionare
- Sarea se consuma doar daca exista consum de apa - regenerare volumetrica
- Economie de sare la regenerare
- Memorie non volatila a istoricului
- Istoric: - volum zilnic si total
 - zile de functionare
 - debit maxim zilnic

Casnic - Industrial - Municipal



Clack®



Sisteme DUPLEX Alternant

Sisteme de dedurizare compuse din 2 tancuri cu rasina cationica si un vas de sare controlate de aceeaasi vana de control capabile sa se schimbe in functionare alternant (unul trateaza apa - unul se regenereaza la nevoie) asigurand un flux de apa dedurizata 24 / 24 in cazul alimentariilor industriale sau casnice cu volume mari

www.imaconcept.ro

office@imaconcept.ro



Date tehnice	Debit	Capacitate tratate @ Doza sare	Conexiuni intrare- iesire	Presiune (min/max)	Capacitate rezervor sare	Temp max	Dimensiuni	
							Sistem / Tanc	Vas sare
Model	(mc / h)	(°Gx c @ kg)	(inch)	(bar)	(kg)	(°C)	(L x l x h) (cm)	(L x l x h) (cm)
EWS 10 Cabinet	0.9	30 @ 1.2	1	2.5 - 7.5	15	49	32 x 50 x 82	-
EWS 15 Cabinet	1.4	45 @ 1.8	1	2.5 - 7.5	25	49	42 x 21 x 79	-
EWS 18 Cabinet	1.6	54 @ 2.16	1	2.5 - 7.5	25	49	42 x 21 x 79	-
EWS 20 Cabinet	1.8	60 @ 2.4	1	2.5 - 7.5	70	49	42 x 21 x 79 49 x 32 x 108	-
EWS 25 Cabinet	2	75 @ 3	1	2.5 - 7.5	70	49	49 x 32 x 108	-
EWS 25 Dublu Corp	2	75 @ 3	1	2.5 - 7.5	100	49	23 x 108	40x40x100
EWS 35 Dublu Corp	2.6	105 @ 4.2	1	2.5 - 7.5	100	49	31 x 138	40x40x100
EWS 50 Dublu Corp	3.1	150 @ 6	1	2.5 - 7.5	100	49	31 x 138	40x40x100
EWS 75 Dublu Corp	4.3	225 @ 9	1	2.5 - 7.5	100	49	36 x 165	40x40x100
EWS 100 Dublu Corp	6	300 @ 12	1	2.5 - 7.5	100 - 140	49	36 x 165	40x40x100
EWS 120 Dublu Corp	6.1	360 @ 14.4	1	2.5 - 7.5	140	49	41 x 186	40x40x100
EWS 140 Dublu Corp	6.2	420 @ 16.8	1	2.5 - 7.5	140	49	41 x 186	40x40x100
EWS E 160 Dublu Corp	6.5	480 @ 19.2	1	2.5 - 7.5	190	49	46 x 186	75 x 120



Date tehnice	Debit	Capacitate tratate @ Doza sare	Conexini intrare- iesire	Presiune (min/max)	Capacitate rezervor sare	Temp max	Dimensiuni	
							/ 1 tanc	Vas sare
Model	(mc / h)	(°Gxmc @ kg)	(inch)	(bar)	(kg)	(°C)	(L x l x h) (cm)	(L x l x h) (cm)
EWS 10 Duplex	0.9	30 @ 1.2	1	2.5 - 7.5	15	49	17 x 80	40x40x100
EWS 15 Duplex	1.4	45 @ 1.8	1	2.5 - 7.5	25	49	18 x 108	40x40x100
EWS 20 Duplex	1.8	60 @ 2.4	1	2.5 - 7.5	70	49	22 x 108	40x40x100
EWS 25 Duplex	2	75 @ 3	1	2.5 - 7.5	100	49	23 x 108	40x40x100
EWS 35 Duplex	2.6	105 @ 4.2	1	2.5 - 7.5	100	49	31 x 138	40x40x100
EWS 50 Duplex	3.1	150 @ 6	1	2.5 - 7.5	100	49	31 x 138	40x40x100
EWS 75 Duplex	4.3	225 @ 9	1	2.5 - 7.5	100	49	36 x 165	40x40x100
EWS 100 Duplex	6	300 @ 12	1	2.5 - 7.5	100 - 140	49	36 x 165	40x40x100
EWS 120 Duplex	6.1	360 @ 14.4	1	2.5 - 7.5	140	49	41 x 186	52 x 90
EWS 140 Duplex	6.2	420 @ 16.8	1	2.5 - 7.5	140	49	41 x 186	52x 90
EWS 160 Duplex	6.5	480 @ 19.2	1	2.5 - 7.5	190	49	46 x 186	75 x 120

Pentru configuratii mai mari va rugam sa ne contactati

IMA CONCEPT

...pentru ca apa inseamna viata

Dedurizatoarele Expert Water retin Calcarul din apa reducand valoarea duritatii apei pana la 0 - 2 grade germane - functie de calitatea apei de intrare. Aceasta duritate se poate regla prin montarea suplimentara a unui robinet de by-pass.

Apa dura duce la:

- pete pe robineti, cabina de dus, vesela, pahare
- consum mare de energie a centralei termice din cauza acoperirii rezistentei cu calcar
- deteriorarea obiectelor sanitare si curatenia greoaie
- aspirarea rufelor si degradarea culorilor
- infundarea tevilor, instalatiilor si a robinetilor
- depuneri de piatra in boiler, masini de spalat
- formarea de pietre la rinichi

Avantaje tehnico - economice

- Design modern si compact
- Functionare automata
- Regenerare dupa Volum consumat de apa la ora aleasa de utilizator tinand cont de saturatia rasilii
- Utilizare inclusiv in industria alimentara
- Afisaj electronic
- Pierdere mica de presiune in functionare
- Sarea se consuma doar daca exista consum de apa - regenerare volumetrica - Economie
- Memorie non volatila a istoricului
- Istoric: - volum zilnic 63 zile si total
 - zile de functionare - debit maxim zilnic
- **Alarma de service cu numarul de telefon si numele centrului de service**

EWS 10-160 Expert Expert Water®

Dedurizatoare Automate-Volumetrice cu

Vana CLACK SUA Expert Casnic - Industrial - Municipal



Portocaliu - Setari



Albastru - Functionare



Rosu - Regenerare



Verde - Istoric

Ecran color in functie de starea sistemului



Sisteme DUPLEX Alternant

Sisteme de dedurizare compuse din 2 tancuri cu rasina cationica si un vas de sare controlate de aceeasi Vana de control, capabile sa se schime in functionare alternant (unul trateaza apa - unul se regenereaza la nevoie) asigurand un flux de apa dedurizata 24 / 24



Sisteme MULTIPLEX

Sisteme de dedurizare compuse din 2,3,4,5 sau 6 tancuri de rasina cationica dirijate de un controller central in functie de debitul necesar in locatie asigurand flux de apa dedurizata 24 / 24 de debite mari cu tancuri de rasina reduce ca volum.



www.imaconcept.ro

office@imaconcept.ro



Date tehnice	Debit	Capacitate tratare @ Doza sare	Conexini intrare- iesire	Presiune (min/max)	Capacitate rezervor sare	Temp max	Dimensiuni	
							Sistem/ Tanc	Vas sare
Model	(mc / h)	(°Gxmc @ kg)	(inch)	(bar)	(kg)	(°C)	(L x l x h) (cm)	(L x l x h) (cm)
EWS E 10 Cabinet	0.9	30 @ 1.2	1	2.5 - 7.5	15	49	32 x 50 x 82	-
EWS E 15 Cabinet	1.4	45 @ 1.8	1	2.5 - 7.5	25	49	42 x 21 x 67	-
EWS E 18 Cabinet	1.6	54 @ 2.16	1	2.5 - 7.5	25	49	42 x 21 x 67	-
EWS E 20 Cabinet	1.8	60 @ 2.4	1	2.5 - 7.5	70	49	42 x 21 x 67 49 x 32 x 108	-
EWS E 25 Cabinet	2	75 @ 3	1	2.5 - 7.5	70	49	49 x 32 x 108	-
EWS E 25 Dublu Corp	2	75 @ 3	1	2.5 - 7.5	100	49	23 x 108	40x40x100
EWS E 35 Dublu Corp	2.6	105 @ 4.2	1	2.5 - 7.5	100	49	31 x 138	40x40x100
EWS E 50 Dublu Corp	3.1	150 @ 6	1	2.5 - 7.5	100	49	31 x 138	40x40x100
EWS E 75 Dublu Corp	4.3	225 @ 9	1	2.5 - 7.5	100	49	36 x 165	40x40x100
EWS E 100 Dublu Corp	6	300 @ 12	1	2.5 - 7.5	100 - 140	49	36 x 165	40x40x100
EWS E 120 Dublu Corp	6.1	360 @ 14.4	1	2.5 - 7.5	140	49	41 x 186	60 x 110
EWS E 140 Dublu Corp	6.2	420 @ 16.8	1	2.5 - 7.5	140	49	41 x 186	60 x 110
EWS E 160 Dublu Corp	6.5	480 @ 19.2	1	2.5 - 7.5	190	49	46 x 186	75 x 120

Pentru sistemele MULTIPLEX va rugam sa ne contactati



Date tehnice	Debit	Capacitate tratare @ Doza sare	Conexini intrare- iesire	Presiune (min/max)	Capacitate rezervor sare	Temp max	Dimensiuni	
							/ 1 tanc	Vas sare
Model	(mc / h)	(°Gxmc @ kg)	(inch)	(bar)	(kg)	(°C)	(L x l x h) (cm)	(L x l x h) (cm)
EWS E 10 Duplex	0.9	30 @ 1.2	1	2.5 - 7.5	15	49	17 x 80	40x40x100
EWS E 15 Duplex	1.4	45 @ 1.8	1	2.5 - 7.5	25	49	18 x 108	40x40x100
EWS E 20 Duplex	1.8	60 @ 2.4	1	2.5 - 7.5	70	49	22 x 108	40x40x100
EWS E 25 Duplex	2	75 @ 3	1	2.5 - 7.5	100	49	23 x 108	40x40x100
EWS E 35 Duplex	2.6	105 @ 4.2	1	2.5 - 7.5	100	49	31 x 138	40x40x100
EWS E 50 Duplex	3.1	150 @ 6	1	2.5 - 7.5	100	49	31 x 138	40x40x100
EWS E 75 Duplex	4.3	225 @ 9	1	2.5 - 7.5	100	49	36 x 165	40x40x100
EWS E 100 Duplex	6	300 @ 12	1	2.5 - 7.5	100 - 140	49	36 x 165	40x40x100
EWS E 120 Duplex	6.1	360 @ 14.4	1	2.5 - 7.5	140	49	41 x 186	52 x 90
EWS E 140 Duplex	6.2	420 @ 16.8	1	2.5 - 7.5	140	49	41 x 186	52x90
EWS E 160 Duplex	6.5	480 @ 19.2	1	2.5 - 7.5	190	49	46 x 186	75 x 120

Pentru configuratii mai mari va rugam sa ne contactati

Dedurizatoarele Keman retin Calcarul din apa reducand valoarea durtatii apei pana la 0 - 2 grade germane - functie de calitatea apei de intrare. Aceasta duritate se poate regla prin montarea suplimentara a unui robinet de by-pass.

Apa dura duce la:

- pete pe robineti, cabina de dus, vesela, pahare
- consum mare de energie a centralei termice din cauza acoperirii rezistentei cu calcar
- deteriorarea obiectelor sanitare si curatenia greoaie
- aspirarea rufelor si degradarea culorilor
- infundarea tevilor, instalatiilor si a robinetilor
- depuneri de piatra in boiler, masini de spalat
- formarea de pietre la rinichi

Avantaje tehnico - economice

- Design modern si compact
- Functionare automata
- Regenerare dupa Volum consumat de apa la ora aleasa de utilizator
- Utilizare inclusiv in industria alimentara
- Afisaj electronic culoare albastra
- Pierdere mica de presiune in functionare
- Sarea se consuma doar daca exista consum de apa
- Regenerare volumetrica
- Istoric: - volum zilnic
- Mentinerea setarilor in cazul penelor de curent



Casnic si Mica Industrie



Date tehnice	Debit	Capacitate tratare @ Doza sare	Conexini intrare- iesire	Presiune (min/max)	Capacitate rezervor sare	Temp max	Dimensiuni	
							Sistem / Tanc	Vas sare
Model	(mc / h)	(°G x mc @ kg)	(inch)	(bar)	(kg)	(°C)	(L x l x h) (cm)	(L x l x h) (cm)
EWK 5 Cabinet	0.4	15@0.6	3/4"	2.5 - 7.5	6	49	35 x 20 x 50	-
EWK 10 Cabinet	0.9	30@1.2	3/4"	2.5 - 7.5	15	49	32 x 50 x 77	-
EWK 15 Cabinet	1.4	45@1.8	3/4"	2.5 - 7.5	25	49	42 x 21 x 74	-
EWK 18 Cabinet	1.6	54@2.2	3/4"	2.5 - 7.5	25	49	42 x 21 x 74	-
EWK 20 Cabinet	1.8	60@2.4	3/4"	2.5 - 7.5	70	49	49 x 32 x 104	-
EWK 25 Cabinet	2	75@3	3/4"	2.5 - 7.5	70	49	49 x 32 x 104	-
EWK 25 Dublu Corp	2	75@3	3/4"	2.5 - 7.5	70	49	23 x 104	35x35x83
EWK 35 Dublu Corp	2.6	105@4.2	3/4"	2.5 - 7.5	70	49	31 x 134	35x35x83
EWK 50 Dublu Corp	3.1	150@6	3/4"	2.5 - 7.5	70	49	31 x 134	35x35x83
EWK 60 Dublu Corp	3.8	180@7.2	1"	2.5 - 7.5	100	49	31 x 140	40x40x100
EWK 75 Dublu Corp	4.3	225@9	1"	2.5 - 7.5	100	49	33 x 155	40x40x100
EWS 100 Dublu Corp	5.5	300@12	1"	2.5 - 7.5	100	49	36 x 179	40x40x100

IMA CONCEPT

...pentru ca apa inseamna viata

dH-Fe-Mn-NH₃

EWMix 10-150 Expert Water®

Sisteme pentru Dedurizare-Deferizare-Demanganizare-Reducere
Amoniu Automate-Volumetrice cu Vana CLACK SUA CI / EI

Sistemele cu rasina mixta Ecomix reduc atat Calcarul din apa cat si Fierul, Manganul, Amoniu in functie de calitatea apei de intrare.

Apa dura in combinatie cu fier - mangan duce la:

- pete pe robineti, cabina de dus, vesela, pahare
- consum mare de energie a centralei termice din cauza acoperirii rezistentei cu calcar
- deteriorarea obiectelor sanitare si curatenia greoaie
- aspirarea rufelor si degradarea culorilor
- infundarea tevilor, instalatiilor si a robinetilor
- depuneri de piatra in boiler, masini de spalat
- formarea de pietre la rinichi

Avantaje tehnico - economice

- Design modern si compact
- Functionare automata
- Regenerare dupa Volum consumat de apa la ora aleasa de utilizator tinand cont de saturatia rasilii
- Utilizare inclusiv in industria alimentara
- Afisaj electronic
- Pierdere mica de presiune in functionare
- Sarea se consuma doar daca exista consum de apa - regenerare volumetrica
- Economie de sare la regenerare
- Memorie non volatila a istoricului
- Istoric: - volum zilnic si total
 - zile de functionare - debit maxim zilnic

Cu un singur sistem instalat rezolvati 4 probleme ale apei: DURITATE - FIER - MANGAN - AMONIU

Casnic - Industrial - Municipal



Clack®

Sisteme DUPLEX Alternant

Sisteme cu rasina mixta compuse din 2 tancuri cu rasina cationica si un vas de sare controlate de aceeasi vana de control capabile sa se schime in functionare alternant (unul trateaza apa - unul se regenereaza la nevoie) asigurand un flux de apa dedurizata 24 / 24 in cazul alimentariilor industriale sau casnice cu volume mari.



www.imaconcept.ro

office@imaconcept.ro



Date tehnice	Debit	Capacitate tratare @ Doza sare	Conexini intrare- iesire	Presiune (min/max)	Capacitate rezervor sare	Temp max	Dimensiuni	
							Sistem / Tanc	Vas sare
Model	(mc/h)	(°Gxmc@kg)	(inch)	(bar)	(kg)	(°C)	(LxIxh)(cm)	(LxIxh)(cm)
EWMix 5 Cabinet	0.2	10 @ 0,5	1	2.5 - 7.5	6	49	35 x 20 x 55	-
EWMix 10 Cabinet	0.4	20 @ 1	1	2.5 - 7.5	15	49	32 x 50 x 82	-
EWMix 15 Cabinet	0.6	30 @ 1,5	1	2.5 - 7.5	25	49	42 x 21 x 79	-
EWMix 18 Cabinet	0.7	36 @ 1,8	1	2.5 - 7.5	25	49	42 x 21 x 79	-
EWMix 20 Cabinet	0.8	41 @ 2	1	2.5 - 7.5	70	49	49 x 32 x 108	-
EWMix 25 Cabinet	1.1	51 @ 2,5	1	2.5 - 7.5	70	49	49 x 32 x 108	-
EWMix 25 Dublu Corp	1.1	51 @ 2,5	1	2.5 - 7.5	100	49	23 x 108	40x40x100
EWMix 35 Dublu Corp	1.3	76 @ 3,7	1	2.5 - 7.5	100	49	31 x 138	40x40x100
EWMix 50 Dublu Corp	1.8	102 @ 5	1	2.5 - 7.5	100	49	31 x 138	40x40x100
EWMix 75 Dublu Corp	2.6	153 @ 7,5	1	2.5 - 7.5	100	49	36 x 165	40x40x100
EWMix 100 Dublu Corp	3.3	204 @ 10	1	2.5 - 7.5	100 - 140	49	36 x 165	40x40x100
EWMix 120 Dublu Corp	4.4	255 @ 12,5	1	2.5 - 7.5	140	49	41 x 186	40x40x100
EWMix 140 Dublu Corp	4.6	279 @ 13,7	1	2.5 - 7.5	140	49	41 x 186	40x40x100

Pentru configuratii mai mari va rugam sa ne contactati



Date tehnice	Debit	Capacitate tratare @ Doza sare	Conexini intrare- iesire	Presiune (min/max)	Capacitate rezervor sare	Temp max	Dimensiuni	
							/ 1 tanc	Vas sare
Model	(mc / h)	(°Gxmc@kg)	(inch)	(bar)	(kg)	(°C)	(LxIxh)(cm)	(LxIxh)(cm)
EWMix 5 Duplex	0.2	10 @ 0,5	1	2.5 - 7.5	6	49	17 x 53	40x40x100
EWMix 10 Duplex	0.4	20 @ 1	1	2.5 - 7.5	15	49	17 x 80	40x40x100
EWMix 15 Duplex	0.6	30 @ 1,5	1	2.5 - 7.5	25	49	18 x 108	40x40x100
EWMix 20 Duplex	0.8	41 @ 2	1	2.5 - 7.5	70	49	22 x 108	40x40x100
EWMix 25 Duplex	1.1	51 @ 2,5	1	2.5 - 7.5	100	49	23 x 108	40x40x100
EWMix 35 Duplex	1.3	76 @ 3,7	1	2.5 - 7.5	100	49	31 x 138	40x40x100
EWMix 50 Duplex	1.8	102 @ 5	1	2.5 - 7.5	100	49	31 x 138	40x40x100
EWMix 75 Duplex	2.6	153 @ 7,5	1	2.5 - 7.5	100	49	36 x 165	40x40x100
EWMix 100 Duplex	3.3	204 @ 10	1	2.5 - 7.5	100 - 140	49	36 x 165	40x40x100
EWMix 120 Duplex	4.4	255 @ 12,5	1	2.5 - 7.5	140	49	41 x 186	52 x 90
EWMix 140 Duplex	4.6	279 @ 13,7	1	2.5 - 7.5	140	49	41 x 186	52x 90

Pentru configuratii mai mari va rugam sa ne contactati

Sistemele cu rasina mixta Ecomix reduc atat Calcarul din apa cat si Fierul, Manganul, Amoniuul
in functie de calitatea apei de intrare.

Apa dura in combinatie cu fier - mangan duce la:

- pete pe robineti, cabina de dus, vesela, pahare
- consum mare de energie a centralei termice din cauza acoperirii rezistentei cu calcar
- deteriorarea obiectelor sanitare si curatenia greoaie
- aspirarea rufelor si degradarea culorilor
- infundarea tevilor, instalatiilor si a robinetilor
- depuneri de piatra in boiler, masini de spalat
- formarea de pietre la rinichi

Avantaje tehnico - economice

- Design modern si compact
- Functionare automata
- Regenerare dupa Volum consumat de apa la ora aleasa de utilizator tinand cont de saturatia rasinii
- Utilizare inclusiv in industria alimentara
- Afisaj electronic
- Pierdere mica de presiune in functionare
- Sarea se consuma doar daca exista consum de apa - regenerare volumetrica
- Economie de sare la regenerare
- Memorie non volatila a istoricului
- Istoric: - volum zilnic 63 zile si total
 - zile de functionare -debit maxim zilnic
- **Alarma de service cu numarul de telefon si numele centrului de service**

Cu un singur sistem instalat rezolvati 4 probleme ale apei: DURITATE - FIER - MANGAN - AMONIUL



Portocaliu - Setari



Albastru - Functionare



Rosu - Regenerare



Verde - Istoric

Ecran color in functie de starea sistemului

Sisteme DUPLEX Alternant

Sisteme de tratare mixte compuse din 2 tancuri cu rasina cationica si un vas de sare controlate de aceeasi Vana de control, capabile sa se schimbe in functionare alternant (unul trateaza apa - unul se regenereaza la nevoie) asigurand un flux de apa tratata 24 / 24



Clack®

Sisteme MULTIPLEX

Sisteme mixte compuse din 2,3,4,5 sau 6 tancuri de rasina cationica dirijate de un controller central in functie de debitul necesar in locatie asigurand flux de apa tratata 24/24 de debite mari cu tancuri de rasina reduce ca volum.

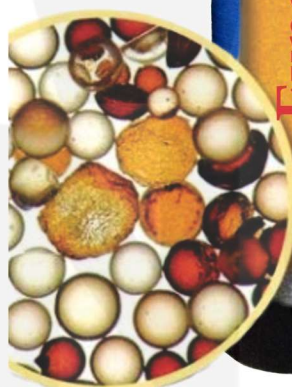



Date tehnice	Debit	Capacitate tratate @ Doza sare	Conexini intrare- iesire	Presiune (min/max)	Capacitate rezervor sare	Temp max	Dimensiuni	
							Sistem /Tanc	Vas sare
Model	(mc/h)	(°Gxmc@kg)	(inch)	(bar)	(kg)	(°C)	(L x l x h) (cm)	(L x l x h) (cm)
EWMix E 5 Cabinet	0.2	10 @ 0,5	1	2.5 - 7.5	6	49	35 x 20 x 55	-
EWMix E 10 Cabinet	0.4	20 @ 1	1	2.5 - 7.5	15	49	32 x 50 x 82	-
EWMix E15 Cabinet	0.6	30 @ 1,5	1	2.5 - 7.5	25	49	42 x 21 x 67	-
EWMix E 20 Cabinet	0.8	41 @ 2	1	2.5 - 7.5	70	49	49 x 32 x 108	-
EWMix E 25 Cabinet	1.1	51 @ 2,5	1	2.5 - 7.5	70	49	49 x 32 x 108	-
EWMix E 25 Dublu Corp	1.1	51 @ 2,5	1	2.5 - 7.5	100	49	23 x 108	40x40x100
EWMix E 35 Dublu Corp	1.3	76 @ 3,7	1	2.5 - 7.5	100	49	31 x 138	40x40x100
EWMix E 50 Dublu Corp	1.8	102 @ 5	1	2.5 - 7.5	100	49	31 x 138	40x40x100
EWMix E 75 Dublu Corp	2.6	153 @ 7,5	1	2.5 - 7.5	100	49	36 x 165	40x40x100
EWMix E 100 Dublu Corp	3.3	204 @ 10	1	2.5 - 7.5	100 - 140	49	36 x 165	40x40x100
EWMix E 120 Dublu Corp	4.4	255 @ 12,5	1	2.5 - 7.5	140	49	41 x 186	40x40x100
EWMix E 140 Dublu Corp	4.6	279 @ 13,7	1	2.5 - 7.5	140	49	41 x 186	40x40x100

Pentru configuratii mai mari va rugam sa ne contactati



Date tehnice	Debit	Capacitate tratare @ Doza sare	Conexini intrare- iesire	Presiune (min/max)	Capacitate rezervor sare	Temp max	Dimensiuni	
							/ 1 tanc	Vas sare
Model	(mc/h)	(°Gxmc/kg)	(inch)	(bar)	(kg)	(°C)	(L x l x h) (cm)	(L x l x h) (cm)
EWMix E 5 Duplex	0.2	10 @ 0,5	1	2.5 - 7.5	6	49	17 x 53	40x40x100
EWMix E 10 Duplex	0.4	20 @ 1	1	2.5 - 7.5	15	49	17 x 80	40x40x100
EWMix E 15 Duplex	0.6	30 @ 1,5	1	2.5 - 7.5	25	49	18 x 108	40x40x100
EWMix E 20 Duplex	0.8	41 @ 2	1	2.5 - 7.5	70	49	22 x 108	40x40x100
EWMix E 25 Duplex	1.1	51 @ 2,5	1	2.5 - 7.5	100	49	23 x 108	40x40x100
EWMix E 35 Duplex	1.3	76 @ 3,7	1	2.5 - 7.5	100	49	31 x 138	40x40x100
EWMix E 50 Duplex	1.8	102 @ 5	1	2.5 - 7.5	100	49	31 x 138	40x40x100
EWMix E 75 Duplex	2.6	153 @ 7,5	1	2.5 - 7.5	100	49	36 x 165	40x40x100
EWMix E 100 Duplex	3.3	204 @ 10	1	2.5 - 7.5	100 - 140	49	36 x 165	40x40x100
EWMix E 120 Duplex	4.4	255 @ 12,5	1	2.5 - 7.5	140	49	41 x 186	52 x 90
EWMix E 140 Duplex	4.6	279 @ 13,7	1	2.5 - 7.5	140	49	41 x 186	52x 90

Pentru configuratii mai mari va rugam sa ne contactati

IMA CONCEPT

...pentru ca apa inseamna viata

NO₃

EWNO3 10-160 Expert Water®

Sisteme pentru Dedurizare-Deferizare-Demanganizare-Reducere
Amoniu Automate-Volumetrice cu Vana CLACK SUA CI / EI

Sistemele cu rasina pentru reducerea nitratilor si sulfatilor din apa.

Apa cu continut de nitrati peste 50mg/l nu este potabila si poate cauza afectiuni in special la nou nascuti.

Prin fierberea apei nitratii se transforma in nitriti - compusi cancerigeni

Pentru aducerea nitratilor din apa la limite normale se impune instalarea unui sistem cu rasina schimbatoare de ioni care se regenereaza cu solutie salina.

Sistemele sunt complet automate, reduc concentratia de nitrati si sulfati din apa dar cresc cantitatea de cloruri.

Avantaje tehnico - economice

- Design modern si compact
- Functionare automata
- Regenerare dupa Volum consumat de apa la ora aleasa de utilizator tinand cont de saturatia rasinii
- Utilizare inclusiv in industria alimentara
- Afisaj electronic
- Pierdere mica de presiune in functionare
- Sarea se consuma doar daca exista consum de apa - regenerare volumetrica
- Economie de sare la regenerare
- Memorie non volatila a istoricului
- Istoric: - volum zilnic si total
 - zile de functionare - debit maxim zilnic

Sisteme DUPLEX Alternant

Sisteme pentru denitrificarea apei compuse din 2 tancuri cu rasina schimbatoare de ioni si un vas de sare controlate de aceeasi Vana de control, capabile sa se schime in functionare alternant (unul trateaza apa - unul se regenereaza la nevoie) asigurand un flux de apa tratata 24 / 24



Clack®



www.imaconcept.ro

office@imaconcept.ro



Date tehnice	Debit	Capacitate tratate @ Doza sare	Conexiuni intrare- iesire	Presiune (min/max)	Capacitate rezervor sare	Temp max	Dimensiuni	
							Sistem / Tanc	Vas sare
Model	(mc/h)	(°Gxmc/kg)	(inch)	(bar)	(kg)	(°C)	(L x l x h) (cm)	(L x l x h) (cm)
EWNO3 5 Cabinet	0.4		1	2.5 - 7.5	6	49	35 x 20 x 55	-
EWNO3 10 Cabinet	0.9		1	2.5 - 7.5	15	49	32 x 50 x 82	-
EWNO3 15 Cabinet	1.4		1	2.5 - 7.5	25	49	42 x 21 x 79	-
EWNO3 20 Cabinet	1.8		1	2.5 - 7.5	70	49	49 x 32 x 108	-
EWNO3 25 Cabinet	2		1	2.5 - 7.5	70	49	49 x 32 x 108	-
EWNO3 25 Dublu Corp	2		1	2.5 - 7.5	100	49	23 x 108	40x40x100
EWNO3 35 Dublu Corp	2.6		1	2.5 - 7.5	100	49	31 x 138	40x40x100
EWNO3 50 Dublu Corp	3.1		1	2.5 - 7.5	100	49	31 x 138	40x40x100
EWNO3 75 Dublu Corp	4.3		1	2.5 - 7.5	100	49	36 x 165	40x40x100
EWNO3 100 Dublu Corp	6		1	2.5 - 7.5	100 - 140	49	36 x 165	40x40x100
EWNO3120 Dublu Corp	6.1		1	2.5 - 7.5	140	49	41 x 186	40x40x100
EWNO3 140 Dublu Corp	6.2		1	2.5 - 7.5	140	49	41 x 186	40x40x100

Pentru configuratii mai mari va rugam sa ne contactati



Date tehnice	Debit	Capacitate tratare @ Doza sare	Conexini intrare- iesire	Presiune (min/max)	Capacitate rezervor sare	Temp max	Dimensiuni	
							/ 1 tanc	Vas sare
Model	(mc / h)	(°Gxmc@kg)	(inch)	(bar)	(kg)	(°C)	(L x l x h) (cm)	(L x l x h) (cm)
EWNO3 5 Duplex	0.4		1	2.5 - 7.5	6	49	17 x 53	40x40x100
EWNO3 10 Duplex	0.9		1	2.5 - 7.5	15	49	17 x 80	40x40x100
EWNO3 15 Duplex	1.4		1	2.5 - 7.5	25	49	18 x 108	40x40x100
EWNO3 20 Duplex	1.8		1	2.5 - 7.5	70	49	22 x 108	40x40x100
EWNO3 25 Duplex	2		1	2.5 - 7.5	100	49	23 x 108	40x40x100
EWNO3 35 Duplex	2.6		1	2.5 - 7.5	100	49	31 x 138	40x40x100
EWNO3 50 Duplex	3.1		1	2.5 - 7.5	100	49	31 x 138	40x40x100
EWNO3 75 Duplex	4.3		1	2.5 - 7.5	100	49	36 x 165	40x40x100
EWNO3 100 Duplex	6		1	2.5 - 7.5	100 - 140	49	36 x 165	40x40x100
EWNO3 120 Duplex	6.1		1	2.5 - 7.5	140	49	41 x 186	52 x 90
EWNO3 140 Duplex	6.2		1	2.5 - 7.5	140	49	41 x 186	52x 90

Pentru configuratii mai mari va rugam sa ne contactati

IMA CONCEPT

...pentru ca apa inseamna viata

NO₃

EWNO3 10-150 Expert Expert Water®

Sisteme pentru Denitrificare Automate-Volumetrice cu Vana CLACK SUA EXPERT

Casnic - Industrial - Municipal

Sistemele cu rasina pentru reducerea nitratilor si sulfatilor din apa.

Apa cu continut de nitrati peste 50mg/l nu este potabila si poate cauza afectiuni in special la nou nascuti

Prin fierberea apei nitratii se transforma in nitriti - compusi cancerigeni

Pentru aducerea nitratilor din apa la limite normale se impune instalarea unui sistem cu rasina schimbatoare de ioni care se regenereaza cu solutie salina.

Sistemele sunt complet automate reduc concentratia de nitrati si sulfati din apa dar cresc cantitatea de cloruri.

Avantaje tehnico - economice

- Design modern si compact
- Functionare automata
- Regenerare dupa Volum consumat de apa la ora aleasa de utilizator tinand cont de saturatia rasiinii
- Utilizare inclusiv in industria alimentara
- Afisaj electronic
- Pierdere mica de presiune in functionare
- Sarea se consuma doar daca exista consum de apa - regenerare volumetrica
- Economie de sare la regenerare
- Memorie non volatila a istoricului
- Istoric: - volum zilnic 63 zile si total
 - zile de functionare - debit maxim zilnic
- Alarma de service cu numarul de telefon si numele centrului de service



Portocaliu - Setari



Albastru - Functionare



Rosu - Regenerare



Verde - Istoric

Ecran color in functie de starea sistemului

Sisteme DUPLEX Alternant

Sisteme pentru denitrificarea apei compuse din 2 tancuri cu rasina schimbatoare de ioni si un vas de sare controlate de aceeaasi Vana de control, capabile sa se schime in functionare alternant (unul trateaza apa - unul se regenereaza la nevoie) asigurand un flux de apa tratata 24 / 24



Clack

Sisteme MULTIPLEX

Sisteme pentru denitrificarea apei compuse din 2,3,4,5 sau 6 tancuri de rasina cationica dirijate de un controller central in functie de debitul necesar in locatie asigurand flux de apa tratata 24/24 la debite mari cu tancuri de rasina reduce ca volum



www.imaconcept.ro

office@imaconcept.ro



Date tehnice	Debit	Capacitate tratare @ Doza sare	Conexini intrare- iesire	Presiune (min/max)	Capacitate rezervor sare	Temp max	Dimensiuni	
							Sistem /Tanc	Vas sare
Model	(mc /h)	(°Gxmc@kg)	(inch)	(bar)	(kg)	(°C)	(L x l x h) (cm)	(L x l x h) (cm)
EWNO3 E 5 Cabinet	0.4		1	2.5 - 7.5	6	49	35 x 20 x 55	-
EWNO3 E 10 Cabinet	0.9		1	2.5 - 7.5	15	49	32 x 50 x 82	-
EWNO3 E 15 Cabinet	1.4		1	2.5 - 7.5	25	49	42 x 21 x 67	-
EWNO3 E 20 Cabinet	1.8		1	2.5 - 7.5	70	49	49 x 32 x 108	-
EWNO3 E 25 Cabinet	2		1	2.5 - 7.5	70	49	49 x 32 x 108	-
EWNO3 E 25 Dublu Corp	2		1	2.5 - 7.5	100	49	23 x 108	40x40x100
EWNO3 E 35 Dublu Corp	2.6		1	2.5 - 7.5	100	49	31 x 138	40x40x100
EWNO3 E 50 Dublu Corp	3.1		1	2.5 - 7.5	100	49	31 x 138	40x40x100
EWNO3 E 75 Dublu Corp	4.3		1	2.5 - 7.5	100	49	36 x 165	40x40x100
EWNO3 E 100 Dublu Corp	6		1	2.5 - 7.5	100 - 140	49	36 x 165	40x40x100
EWNO3 E 120 Dublu Corp	6.1		1	2.5 - 7.5	140	49	41 x 186	40x40x100
EWNO3 E 140 Dublu Corp	6.2		1	2.5 - 7.5	140	49	41 x 186	40x40x100

Pentru configuratii mai mari va rugam sa ne contactati.



Date tehnice	Debit	Capacitate tratare @ Doza sare	Conexini intrare- iesire	Presiune (min/max)	Capacitate rezervor sare	Temp max	Dimensiuni	
							/ 1 tanc	Vas sare
Model	(mc/h)	(°Gxmc@kg)	(inch)	(bar)	(kg)	(°C)	(L x l x h)(cm)	(L x l x h)(cm)
EWNO3 E 5 Duplex	0.4		1	2.5 - 7.5	6	49	17 x 53	40x40x100
EWNO3 E 10 Duplex	0.9		1	2.5 - 7.5	15	49	17 x 80	40x40x100
EWNO3 E 15 Duplex	1.4		1	2.5 - 7.5	25	49	18 x 108	40x40x100
EWNO3 E 20 Duplex	1.8		1	2.5 - 7.5	70	49	22 x 108	40x40x100
EWNO3 E 25 Duplex	2		1	2.5 - 7.5	100	49	23 x 108	40x40x100
EWNO3 E 35 Duplex	2.6		1	2.5 - 7.5	100	49	31 x 138	40x40x100
EWNO3 E 50 Duplex	3.1		1	2.5 - 7.5	100	49	31 x 138	40x40x100
EWNO3 E 75 Duplex	4.3		1	2.5 - 7.5	100	49	36 x 165	40x40x100
EWNO3 E 100 Duplex	6		1	2.5 - 7.5	100 - 140	49	36 x 165	40x40x100
EWNO3 E 120 Duplex	6.1		1	2.5 - 7.5	140	49	41 x 186	52 x 90
EWNO3 E 140 Duplex	6.2		1	2.5 - 7.5	140	49	41 x 186	52x 90

Pentru configuratii mai mari va rugam sa ne contactati.

IMA CONCEPT

...pentru ca apa inseamna viata

SO₄ + Fe + Mn

EWSO4 30-100 Expert Water®

**Filtre automate EWH2S Pentru Desulfurare - Vana Clack Impression
SUA - Regenerare la timp - Desulfurare, Deferizare, Demanganizare
Casnic - Industrial - Municipal**

Sistemul unic in Romania

Este un sistem 3 in 1. Cu acesta rezolvati problema fierului, a manganului, a hidrogenului sulfurat.

Foloseste tehnologii de ultima ora din domeniul tratarii apei - camera de aer comprimat si mediu catalitic.

Nu se foloseste compresor pentru injectie aer si nu are consumabile.

In prima faza fierul, manganul si hidrogenul sulfurat sunt oxidate, functie asigurata de camera de aer comprimat prin care intra apa in sistem, urmand ca in a doua etapa elementele sa fie retinute pe mediul catalitic. Regenerarea sistemului consta in inlocuirea camerei de aer si spalarea mediului catalitic - acestea facandu-se automat de catre vana de control inteligenta de ultima generatie adaptata pentru a putea executa toate etapele regenerarii.



www.imaconcept.ro

office@imaconcept.ro



Date tehnice	Debit	Capacitate tratare @ Doza sare	Conexini intrare- iesire	Presiune (min/max)	Capacitate rezervor sare	Temp max	Dimensiuni	
							/ 1 tanc	Vas sare
Model	(mc/h)	(°Gxmc@kg)	(inch)	(bar)	(kg)	(°C)	(L x l x h)(cm)	(L x l x h)(cm)
EWSO4 30	1.2		1	2.5 - 7.5	100	49	31 x 138	40x40x100
EWSO4 50	1.8		1	2.5 - 7.5	100	49	31 x 138	40x40x100
EWSO4 75	2.6		1	2.5 - 7.5	100	49	36 x 165	40x40x100
EWSO4 100	3.2		1	2.5 - 7.5	100 - 140	49	36 x 165	40x40x100

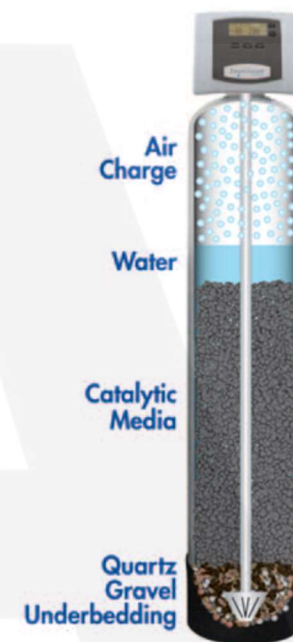

Pentru configuratii mai mari va rugam sa ne contactati.

IMA CONCEPT

...pentru ca apa inseamna viata

SO₄MIX

EWSO4MIX 30-100 Expert Water®

Filtre automate EWSO4MIX Pentru Desulfurare - Vana Clack Impression
SUA - Regenerare la timp - Desulfurare, Deferizare, Demanganizare
Casnic - Industrial - Municipal

Sistemul unic in Romania

Este un sistem 5 in 1. Cu acesta rezolvati problema fierului, a manganului, a hidrogenului sulfurat, a durtatii si a amoniului.

Foloseste tehnologii de ultima ora din domeniul tratarii apei - camera de aer comprimat si rasini mixte schimbatoare de ioni.

Nu se foloseste compresor pentru injectie aer iar singurul consumabil este sarea pastilata pentru regenerarea rasinii.

In prima faza fierul, manganul si hidrogenul sulfurat sunt oxidate, functie asigurata de camera de aer comprimat prin care intra apa in sistem, urmand ca in a doua etapa elementele sa fie retinute pe rasina cationica. Regenerarea sistemului consta in inlocuirea camerei de aer si regenerarea rasinii schimbatoare de ioni - acestea facandu-se automat de catre vana de control inteligenta de ultima generatie adaptata pentru a putea executa toate etapele regenerarii.



www.imaconcept.ro
office@imaconcept.ro

Filtre automate EWSO4MIX Pentru Desulfurare - Vana Clack Impression
SUA - Regenerare la timp - Desulfurare, Deferizare, Demanganizare
Casnic - Industrial - Municipal





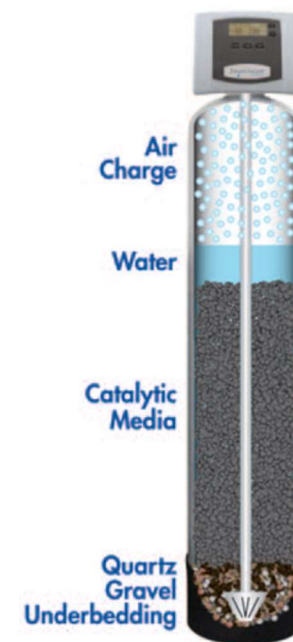



Date tehnice	Debit	Capacitate tratare @ Doza sare	Conexini intrare- iesire	Presiune (min/max)	Capacitate rezervor sare	Temp max	Dimensiuni	
							/ 1 tanc	Vas sare
Model	(mc/h)	(°Gxmc@kg)	(inch)	(bar)	(kg)	(°C)	(L x l x h)(cm)	(L x l x h)(cm)
EWSO4 30	1.2		1	2.5 - 7.5	100	49	31 x 138	40x40x100
EWSO4 50	1.8		1	2.5 - 7.5	100	49	31 x 138	40x40x100
EWSO4 75	2.6		1	2.5 - 7.5	100	49	36 x 165	40x40x100
EWSO4 100	3.2		1	2.5 - 7.5	100 - 140	49	36 x 165	40x40x100



Pentru configuratii mai mari va rugam sa ne contactati.

Componente Dedurizatoare si Filtre automate

Articol	Debit max (l/h)	Limite presiune (bar)	Conexiuni intrare-iesire	Finete filtrare (microni)	Limite temp (°C)	Dimensiuni (lungime x diametru)
 <p>Vana Filtrare CLACK TC-1"-Timp</p> <p>(Vana - DLFC - Transformator - Conectori 1") Producator: CLACK SUA</p>						
 <p>Vana Dedurizare CLACK CI-1"-Volum</p> <p>(Vana-DLFC-Injector-Transformator - Conectori) Producator: CLACK SUA</p>						
 <p>Vana Dedurizare CLACK EXPERT -1" Volum</p> <p>Conectori)*** Meniu extins Producator: CLACK SUA</p>						
 <p>Vana Dedurizare CI -1" DUPLEX Alternant</p> <p>(Vana-DLFC-Injector-Transformator - Conectori) Producator: CLACK SUA</p>						
 <p>By Pass Vana Clack 1"</p>						
 <p>Transformator Vana Clack</p>						
 <p>Set Conectori Clack 1"</p>						

Componente Dedurizatoare si Filtre automate



Articol	Nr imagine	COD
Placa Electronica CLACK CI	9	V3108
Placa Electronica CLACK Expert	9	
Motor angrenare piston vana CLACK	1	V3107
Roata dintata vana CLACK	2	C3004
Structura interna vana CLACK	3	V3005
Piston principal vana CLACK	4	V3174
Piston saramura vana CLACK	5	V3011
Senzor volum vana CLACK	6	V3003
CHEIE SERVICE CLACK		V3193
VANA TANC 2 DUPLEX CLACK	8	1191

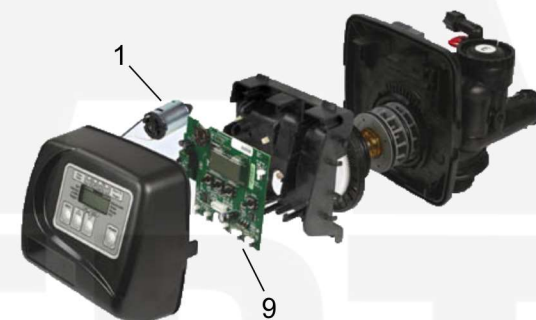
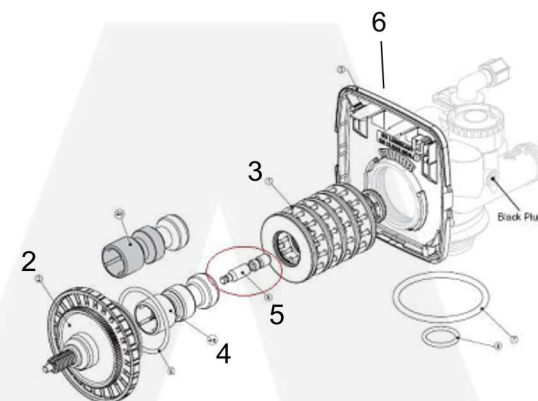

Medii Filtrante

Articol	Cantitate	Limite presiune (bar)	Conexiuni intrare-iesire	Finete filtrare (microni)	Limite temp (°C)	Dimensiuni (lungime x diametru)
Pietris 3-5 mm	1 l					
- Pentru pat inferior						
Pietris 0.8 - 1.2 mm	1 l					
- Amestec sau Filtrare mecanica 50μ						
Rasina ECOMIX	1 l					
- Retine Duritate-Fier-Mangan-Amoniu-Oxidabilitate						
Carbune Activ	1 l					
Pyrolox -pur(gata preparat)	1 l					
- Retine Fier, Mangan, Hidrogen sulfurat						
Filter AG	1 l					
Turbidex	1 l					
-filtrare mecanica 5 μ						
Aqua DOL	1 l					
Rasina Dedurizare	1 l					
Pure						
Rasina Dedurizare	1 l					
DOW Chemicals						
Rasina Denitrificare	1 l					

Descrierea sistemului :

Furnizeaza apa demineralizata produsa pe principiul osmozei inverse.
Reduce concentratia de saruri minerale din apa pana la 96-99 %.
Se va folosi **doar apa fara** concentratie de Clor Liber , Duritate , Fier , Mangan.

Designul sistemului Unitate completa cu fir, preasamblata, gata de instalare, cablu (3 m):

- Functionare complet automatizata - oprire functionare la rezervor plin
- Cadru de bază din oțel inoxidabil sau aluminiu cu panoul frontal din inox sau forex unde sunt amplasate debitmetrele, manometrele si monitorul de conductivitate care masoara instant conductivitatea permeatului produs;
- Pompa de inalta presiune cu zgomot redus;
- Membrana osmotica in spirala cu eficienta energetica crescuta;
- Vase de presiune INOX
- Robinet apa de alimentare, prelevare de probe, electrovana de admisie solenoid, senzor de presiune joasa pentru apa de alimentare, debitmetru rezistent la vibrații, manometre pentru pompe de presiune permeat, valve de ajustare a debitului pentru permeat, concentrat si recirculare - functia de recirculare creste rata de recuperare.

Optional sistemele se pot echipa cu - Sistem de control cu microprocesor, aparataj electric pentru controlul pompei de înaltă presiune, monitorizarea complet automatizata și controlul sistemului. Afisaj cu 2 linii de text pentru vizualizarea procesului RO și de afișare a stării de funcționare , afiseaza conductivitatea de iesire, conductivitate de intrare , alarma la lipsa apa, alarma la conductivitate inalta.



Sistemele se pot folosi in aplicatii industriale si in aplicatii casnice unde conductivitatea apei este crescuta.

Sistemele se pot personaliza la cerere (dimensiuni - optiuni - echipari)

Date tehnice	Debit	Coefficient Rejectie Min-Max	Recuperare	Presiune Lucru	Nr Membrane / Tip	Voltaj	Consum	Presiune apa Intrare	Temp apa (min- max)	Temp Ambie nt max	Inaltime	Latime	Adancime	Greutate (aprox - gol)
Model	(l/h)	(%)	(%)	(bar)		(V/Hz)	(Kw)	(bar)	(C)	(C)	(mm)	(mm)	(mm)	(kg)
EWRO 250	250	96-99	50-75	6 - 12	1 x 4040	220 / 50	0.55	2 - 6	5 - 35	40	1250	500	300	60
EWRO 500	500	96-99	50-75	6 - 12	2 x 4040	220 / 50	0.75	2 - 6	5 - 35	40	1250	500	300	75
EWRO 750	750	96-99	50-75	6 - 12	3 x 4040	3x400 / 50	1.5	2 - 6	5 - 35	40	1550	750	550	100
EWRO 1000	1000	96-99	50-75	6 - 12	3 x 4040	3x400 / 50	1.5	2 - 6	5 - 35	40	1550	660	700	115
EWRO 1250	1250	96-99	50-75	6 - 12	5 x 4040	3x400 / 50	2.2	2 - 6	5 - 35	40	1550	660	700	195
EWRO 1500	1500	96-99	50-75	6 - 12	6 x 4040	3x400 / 50	3	2 - 6	5 - 35	40	1650	2550	135	230
EWRO 2000	2000	96-99	50-75	6 - 12	8 x 4040	3x400 / 50	3	2 - 6	5 - 35	40	1650	2550	150	270
EWRO 2500	2500	96-99	50-75	6 - 12	10 x 4040	3x400 / 50	4	2 - 6	5 - 35	40	1650	3550	180	320
EWRO 3000	3000	96-99	50-75	6 - 12	12 x 4040	3x400 / 50	4	2 - 6	5 - 35	40	1650	3550	195	390
EWRO 4300	4300	96-99	50-75	6 - 12	3 x 8040	3x400 / 50	5.5	2 - 6	5 - 35	40	1900	2800	750	450
EWRO 5400	5400	96-99	50-75	6 - 12	4 x 8040	3x400 / 50	5.5	2 - 6	5 - 35	40	1900	2800	750	500
EWRO 7000	7000	96-99	50-75	6 - 12	5 x 8040	3x400 / 50	7.5	2 - 6	5 - 35	40	1900	3800	750	600
EWRO 8000	8000	96-99	50-75	6 - 12	6 x 8040	3x400 / 50	11	2 - 6	5 - 35	40	1900	3800	800	700
EWRO 9500	9500	96-99	50-75	6 - 12	7 x 8040	3x400 / 50	11	2 - 6	5 - 35	40	1900	4800	800	800
EWRO 12000	12000	96-99	50-75	6 - 12	9 x 8040	3x400 / 50	11	2 - 6	5 - 35	40	1900	4800	800	900

Medii Filtrante

Articol	Conexiuni intrare-iesire	Finete filtrare (microni)	Limite temp (°C)	Dimensiuni (lungime x diametru)
MEMBRANA OSMOZA 4040 ALL		0.001		100X10
CARCASA MEMBRANA 4040				
CAPAC CARCASA MEMBRANA 4040				
ORING CAPAC CARCASA MEMBRANA 4040				
DEBITMETRU RO 10 GPM				
DEBITMETRU RO 10 GPM CU REGLAJ				
DEBITMETRU RO 2 GPM				
DEBITMETRU RO 2 GPM CU REGLAJ				
DEBITMETRU RO 5 GPM				
DEBITMETRU RO 5 GPM CU REGLAJ				

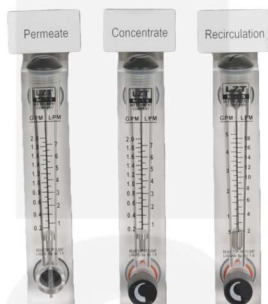

Medii Filtrante

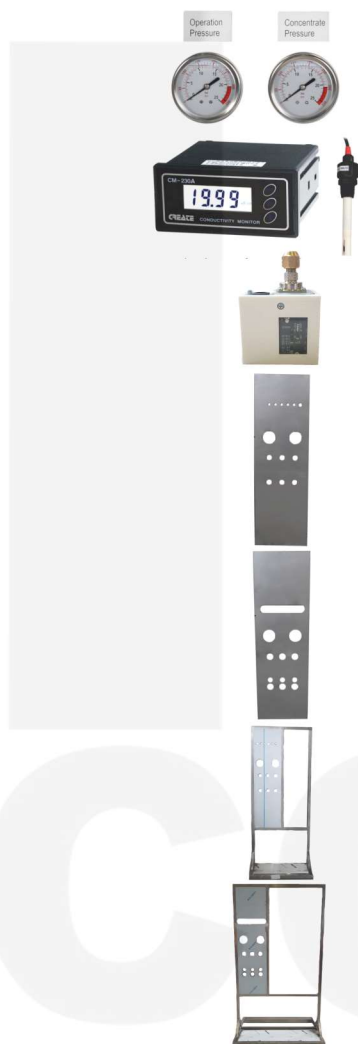

Articol	Conexiuni intrare-iesire	Finete filtrare (microni)	Limite temp (°C)	Dimensiuni (lungime x diametru)
MANOMETRU PANOU D63 0-25 BAR				
MONITOR RO CONDUCTIVITATE				
PRESOSTAT MINIM				
PANOU INOX OSMOZA IND 250-500				
PANOU INOX OSMOZA IND 750-1000				
CADRU INOX OSMOZA INDUSTRIALA 250-500L				
CADRU INOX OSMOZA INDUSTRIALA 750-1000L				

Medii Filtrante

Articol	Conexiuni intrare- iesire	Finete filtrare (microni)	Limite temp (°C)	Dimensiuni (lungime x diametru)
MOTOR 220V - POMPA EWRO 500 0.75KW				
MOTOR 220V - POMPA EWRO 250 - 0.55KW				
POMPA RO INDUSTRIAL 500L				
POMPA RO INDUSTRIAL 250L				
CAPAC POMPA RO 250-500				
ADAPTOR POMPA - MOTOR RO ewro250-500				
POMPA GRUNDFOS CMI 3-12 SAU SIMILAR				
TABLOU OSMOZA INDUSTRIAL EWRO 750-1000				
TABLOU OSMOZA INDUSTRIAL EWRO 250-500				



IMA CONCEPT

...pentru ca apa inseamna viata

EWRO 50-400-800 Expert Water®

Purificatoare apa prin Osmoza Inversa

Casnic - Semi Industrial

Cu totii suntem constienti de cat de important este sa bem o apa sanatoasa si sigura.

Pentru aceasta acum nu mai este nevoie sa stati la cozi, sa carati bidoane si sa ocupati spatiul din casa dvs cu bidoane de plastic.

Puteti avea o apa de calitate foarte buna direct pe chiuveta bucatariei dvs.

Sistemele de purificare prin osmoza inversa Expert Water folosesc ultimele noutati din domeniu aducand plus de calitate apei.

Utilizate pe larg in anumite domenii din industrie si spitale, aceste sisteme au inceput sa fie tot mai mult folosite si in domeniul casnic mai ales datorita calitatii crescute a apei produse, a fiabilitatii si a componentelor de mare calitate din acest sistem!

Printre compusii diminuati din apa sunt: arseniu, bariu, seleniu, amoniu, bicarbonati, bromuri, clor liber, cloruri, magneziu, sodiu, sulfati, tanin, zinc, aluminiu, turiditate, gust neplacut si miros.

Sistemul de osmoza inversa are o constructie foarte simpla si ocupa un spatiu limitat sub chiuveta.

Pe chiuveta se instaleaza un robinet, separat decat cel existent, care va furniza apa plata de cea mai buna calitate pe care o folosim pentru prepararea mancarii, ceaiului, cafelei, etc dar si mai important, pentru baut.

Costurile consumabilelor sunt mult mai mici decat achizitia de apa plata din comer!

Va asigura apa de cea mai buna calitate si veti avea siguranta acestui fapt tot timpul fiind un echipament propriu!



- Etapa 1: - Filtru de sedimente (5 microni), elimina impuritatile mecanice mai mari de 5 microni: nisip, rugina, mil, etc
- Etapa 2: - Filtru cu carbon activat, imbunatateste gustul, mirosul si culoarea apei
- Etapa 3: - Filtru de sedimente (1 micron), elimina impuritatile mecanice mai mari de 1 micron.
- Etapa 4: - Membrana osmotica - cel mai important element al sistemului RO. Membrana are finetea de filtrare de 0,001 microni si elimina contaminantii organici si anorganici, solidele dizolvate, metalele grele, nitratii, fenolii
- Etapa 5: - Filtru cu carbune activ, elimina gazele si substantele volatile din apa, imbogateste gustul si mirosul apei.
- Etapa 6: - Filtru final cu granule remineralizatoare - pe acelasi principiu ca in natura se reintroduc minerale controlat

www.imaconcept.ro
office@imaconcept.ro



Articol	Capacitate de productie (l/h)	Presiune apa (min/max bar)	Temperatur a apa (° C)	Dimensiuni (lungime x latime x inaltime)
Sistem Ultrafiltrare	30 l/h	1 - 5	4-49	16x35x52
Purificator Casa- Birou prin Osmoza Inversa 6 Trepte	8	3-7	5-35	Corp:16x35x52 Tanc:30x35
Purificator Casa- Birou prin Osmoza Inversa 6 Trepte + Pompa Booster	11	1.5 - 7	5-35	Corp:16x35x52 Tanc:30x35
Purificator Prin Osmoza Inversa 4 Trepte - 400 gpd - 60 l/h	60	1.5 - 7	5-35	Corp:16x35x65 Tanc:30x35
PRODUCE 1440 LITRII / 24 ORE				
Purificator Prin Osmoza Inversa 4 Trepte - 800 gpd - 120 l/h	120	1.5 - 7	5-35	Corp:16x35x70 Tanc:30x35
PRODUCE 2880 LITRII / 24 ORE				



Sterilizator UV 6 W
Anihileaza Bacteriile din apa

120

0 - 8

5-35

26x5



Cartus Alcalizare In Line
Creste pH-ul apei

0 - 10

5 - 35



Cartus Carbune Activ 10"



Cartus in line Carbune Activ



Cartus in line Denitrificare



Cartus in line Remineralizare



Cartus in line Demineralizare



Cartus PP 10" - 1 Micron



Cartus PP 10" - 5 Microni



Membrana Osmoza 50 GPD



**Membrana Osmoza Filmtec
50 GPD**



Membrana Osmoza 400 GPD

Componente Purificatoare Casa si Birou









Articol	Capacitate de productie (l/h)	Presiune apa (min/max bar)	Temperatur a apa (° C)	Dimensiuni (lungime x latime x inaltime)
BATERIE 3 CAI				
<i>Preia functiile bateriei clasice Apa Calda-Rece si Functiile bateriei de osmoza</i>				
BATERIE OSMOZA Simpla				
Dubla				
Carcasa Membrana Osmoza 50-75 GPD				
Carcasa Membrana Osmoza 400 GPD				
Cartus in line - Refill				
Carcasa Filtru 1/4"				
Cartus Refill 10"				

Componente Purificatoare Casa si Birou



Articol	Capacitate de productie (l/h)	Presiune apa (min/max bar)	Temperatur a apa (°C)	Dimensiuni (lungime x latime x inaltime)
Clema Cartus 50-50 mm				
Clema Cartus 50-60 mm				
Conector (L) 6 mm IN-IN-OUT				
Conector (T) 6 mm IN-IN-OUT				
Conector Cot 1/4" 6 mm				
Conector Cot cu Supapa Sens 1/8" 6mm				
Conector Drept 1/4" 6 mm				

Componente Purificatoare Casa si Birou

Articol	Capacitate de productie (l/h)	Presiune apa (min/max bar)	Temperatur a apa (° C)	Dimensiuni (lungime x latime x inaltime)
 Conector Drept 1/8" 6 mm				
 Conector 6 mm - 6 mm				
 Conector 6 mm - 10 mm				
 TEU EGAL 6 mm FURTUN				
 TEU 6 mm - 6 mm 1/4"				
 VALVA 4 CAI				
 Furtun 6 mm				
Furtun 10 mm				

Componente Purificatoare Casa si Birou



Kit Alimentare Purificator 1/2 FE 1/2 FI 6 mm



Kit Evacuare Purificator



POMPA OSMOZA 400 GPD



POMPA OSMOZA 50-75 GPD



TRANSFORMATOR POMPA OSMOZA 50-75 GPD



TRANSFORMATOR POMPA OSMOZA 400 GPD

Articol	Capacitate de productie (l/h)	Presiune apa (min/max bar)	Temperatur a apa (° C)	Dimensiuni (lungime x latime x inaltime)
Kit Alimentare Purificator 1/2 FE 1/2 FI 6 mm				
Kit Evacuare Purificator				
POMPA OSMOZA 400 GPD				
POMPA OSMOZA 50-75 GPD				
TRANSFORMATOR POMPA OSMOZA 50-75 GPD				
TRANSFORMATOR POMPA OSMOZA 400 GPD				

Componente Purificatoare Casa si Birou



RESTRICTOR DEBIT



ROBINET PE FURTUN 6 mm - 6 mm



ROBINET TANC 1/4" 6 mm



Splitter 6 mm



TANC OSMOZA 3,2 GALOANE

TANC OSMOZA 2,6 GALOANE



VALVA CU PURJARE

La alimentare se deschide 14 secunde pentru purjare apoi se comporta ca un restrictor de debit reglabil

Componente Purificatoare Casa si Birou



Articol	Capacitate de productie (l/h)	Presiune apa (min/max bar)	Temperatur a apa (° C)	Dimensiuni (lungime x latime x inaltime)
Valva Presiune Inalta				
Valva Presiune Joasa				
Valva Solenoid				
Cheie membrana osmoza 75 gpd				
Cheie cartuse 10 Inc, Purificator				

IMA CONCEPT

...pentru ca apa inseamna viata

EWROHC- 50

Dozator APA Calda-Rece cu Purificare prin Osmoza Inversa sau Ultrafiltrare

Expert Water®

Office si Casnic



Caracteristici :

SISTEMUL FURNIZEAZA:

- APA RECE si APA CALDA PURIFICATA prin Osmoza Inversa
- posibilitatea setarii temperaturii
- sistem monobloc compact
- ecran LCD
- racire cu compresor cu freon

TRATAREA APEI IN SISTEM :

1. Filtru de sedimente 5 microni: elimina impuritatile din apa mai mari de 5 microni (sedimente, rugina, mil, etc.)
2. Filtru cu carbune activ retine Clorul si imbunatateste gustul, mirosul si culoarea apei;
3. Filtru de sedimente 1 micron: elimina impuritatile din apa mai mari de 1 micron;
4. Membrana semipermeabila cu finete de filtrare de 0.001 microni: elimina contaminantii organici si anorganici, solidele dizolvate, metale grele, nitratii, fenolii, elemente radioactive;
5. Filtru cu carbune activ: elimina gazele si substantele volatile din apa, imbogateste gustul si mirosul apei;
6. Cartus remineralizare: reintroduce mineralele necesare in apa;
7. Sterilizator UV – elimina bacteriile din apa - OPTIONAL (recomandat pentru apele de put).

Pretabil pentru: Apă municipală sau puț forat

Capacitate de producție apă (l/h): 7-10 l/h

Alimentare electrică/putere (V/Hz/W): 220-240 V

Capacitate de încălzire (L/H): 6 l/h la 90-95°C

Capacitate de răcire (L/H): 2 l/h la 7-10°C

Greutate netă : 25 kg

Presiunea apei folosite: 2 - 5 bar

Dimensiuni:

- Pe Podea: 40 x 28 cm h: 115 cm - 3900 LEI
- Pe blat: 40 x 28 cm h: 150 cm - 3400 LEI



**NU MAI AVETI NEVOIE DE
Ambalaje Plastic - Transport - Aprovizionare - Spatii depozitare**

www.imaconcept.ro
office@imaconcept.ro



Pret: 10000 LEI

Sistemul este controlat de un senzor de atingere. Poate functiona in acelasi timp cu robinetul normal de apa. Revelation II ofera o combinatie intre tehnologia inalta, design-ul elegant si un sistem computerizat avansat, furnizand astfel usurinta in operatii si performanta.

Unitatea centrala se afla sub chiuveta, pentru a nu ocupa spatiu pe suprafetele bucatariei si contine 9 placute de ionizare si un sistem de filtrare in cele doua cartuse incorporate. Filtrele trateaza apa dvs. de la robinet retinand clorul si sedimentul in timp ce camera de electroliza de mare putere ionizeaza apa, facand-o alcalina sau acida dupa preferintele dvs. Inainte de a instala sistemul efectuati o analiza chimica si bacteriologica a apei pentru a fi siguri ca alimentati acest aparat cu o apa potabila.

Revelation II este proiectat pentru a fi simplu de folosit. Are doi robineti mobili, unul care ofera apa alcalina si unul care ofera apa acida. In momentul in care selectati un nivel de alcalinitate, robinetul de sus ofera apa alcalina, iar cel de jos ofera apa acida, astfel ca este foarte simplu sa colectati ambele tipuri de apa!

Avantajele sistemului:

- Butonul Turbo: o simpla apasare creeaza apa cu cel mai mare pH-11, pentru gatit si pentru dezinfectat.
- Noua placute din platina si titan: cu slot-uri integrate, dupa o tehnologie patentata.
- 325 wati: putere suficienta pentru a ioniza apa oricarei case.
- Sistem electric SMPS: reduce incingerea si marestre precizia ionizarii.
- Display LCD in 7 culori: afiseaza pH-ul, durata de viata a filtrelor si altele.
- Filtreaza si revitalizeaza apa pana in momentul in care aceasta sa fie ionizata!
- Nu introduce sulfiti in apa- nu folositi apa nepotabila la alimentarea sistemului!
- Design neintrecut: eleganta este pe masura performantei de top a sistemului.

Apa alcalina ionizata mai este denumita si "apa vie" sau , "apa structurata", "apa anti-imbatranire", "apa energizanta", pentru ca are 3 mari calitati:

- ajuta sangele sa isi pastreze alcalinitatea si sa neutralizeze depunerile acide, are efect antioxidant;
- poate elimina radicalii liberi raspunzatori de cresterea riscului de aparitie al bolilor si inhiba alte reactii de oxidare;
- are o structura de 3 ori mai mica fapt ce ii permite sa hidrateze mult mai bine organismul, celulele.
- Este o apa ce ajunge la creier in 60 de secunde spre deosebire de apa normala care ajunge in 10 minute.

Debit: 1-2 l/min

Debit min de alimentare: 2 l/min

Presiune minima: 1.5 bar

Dimensiuni:

Baterie: h:26 cm - diametru 6.5 cm

Unitate sub chiuveta: 34x34x15 cm

Trepte de PH- 9 (2 acid-1 neutru- 4 alcalin -1 turbo alcalin-PH 11)

Trepte pentru setare putere in placile de hidroliza: 76 unitati

Display-ul LCD in 7 culori afiseaza pH-ul, si durata de viata a filtrelor.



Sterilizarea cu ultraviolete este sigura si foarte eficienta. Acest procedeu nu modifica gustul, mirosul si culoarea apei, ci doar inlatura riscul de imbolnavire cauzat de contaminarea microbiana, facand apa sigura pentru consumul uman

Cand bacteriile, virusii si alte microorganisme sunt expusa la radiatia UV, sunt distruse, ceea ce inseamna ca ele nu mai reprezinta un pericol pentru sanatatea noastra.

Puterea de iradiere este data de intensitatea UV si timpul de expunere.

Foloseste tehnologii de ultima ora din domeniul tratarii apei - camera de aer comprimat si rasini mixte schimbatoare de ioni.

Instalati un sterilizator Expert Water si veti avea siguranta unei ape microbiologic pure!

- Instalare simpla - Intrare-iesire si alimentare electrica 220V;
- Design modern si compact;
- Corpul sterilizatorului este executat din inox;
- Sterilizatoare destinate atat zonelor rezidentiale, cat si industriale.





Date tehnice	Debit	Putere lampa UV	Conexini intrare- iesire	Presiune (min/max)	Temp max	Dimensiuni
Model	(mc/h)	W	(inch)	(bar)	(°C)	(L x l x h)(cm)
EWUV 6	0.12	6	1/4"	8	4 - 50	
EWUV 55	2,8	55	3/4"	8	4 - 50	
EWUV 110	5,5	2 X 55	1"	8	4 - 50	96,5 L X 11Ø
EWUV 165	8	3 X 55	1,5"	8	4 - 50	96,5 L X 13.3 Ø
EWUV 220	11	4 X 55	1,5"	8	4 - 50	96,5 L X 16,8 Ø

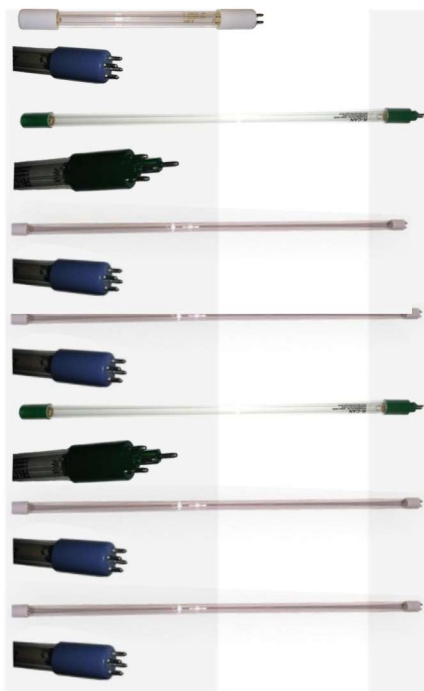

ARTICOL	Lungime (cm)	Diametru (cm)	Schimb Ore
LAMPA UV 6 W	22	1.7	3000
LAMPA UV 25 W STERILIGHT	48	1.7	9000
LAMPA UV 30 W	47	1.7	9000
LAMPA UV 30 W	65	1.7	9000
LAMPA UV 37 W STERILIGHT	83	1.7	9000
LAMPA UV 40 W ETR	85	1.7	9000
LAMPA UV 55 W ETR	93	1.7	9000
TRANSFOMATOR UV 40 W - 55 W			
TRANSFOMATOR UV 6 W			
CONTROLER 55 W			
<i>cu counter de zile pentru inlocuire</i>			