

IMA CONCEPT

Catalogue 2026

www.imaconcept.ro

Expert Water®

Purifyo



www.imaconcept.ro
office@imaconcept.ro

Mechanical filters of 10 "and 20" length with Polypropylene Cartridges

System description:

Mechanical filters are the simplest filters that can be used in cold water treatment and they have a very important role in protecting the equipment that follows in the water treatment line , protecting them .

Available in two 10 "and 20" length variants, they can be used with any 1, 5, 10, 20 micron polypropylene cartridge or block / granular active carbon cartridges where applications require it.

The filters are delivered fully equipped with wall and wrench support polypropylene cartridge.
Also, both filter variants are designed with a manual air vent.

Any sediment cartridge is recommended to be replaced for up to 6 months for bacteriological reasons even if it is not dirty !

- * Easy to connect through the interior filter of 1" - 3/4" - 1/2 "
- * Cartridge easy to change
- * Ideal for the entire location or different equipment requiring a filter
- * Does not require electricity or drainage
- * Applicable to drinking water
- * Low pressure loss in operation (for clean cartridge)



The filters can be used both in **industrial applications** and in **domestic applications** where a sediment filter is needed

Sediment Filter 10 "and 20" length with Polypropylene Cartridges PP



Article	Maximum Flow Rate (l/h)	Pressure Limits (bar)	Input / Output connections	Microns	Limits of temp (°C)	Dimensions (length x diameter)
Filter FD 10	3500	1 - 8	1"	20 - 10 - 5 - 1	4-50	30 x 14
<i>Including</i> -Wrench -Wall support -Cartridges 1,5,10 or20 μ			3/4" 1/2"			
Filter FD 20	5000	1 - 8	1"	20 - 10 - 5 - 1	4-50	59 X 14
<i>Including</i> -Wrench -Wall support -Cartridges 1,5,10 or20 μ						

Centrifugal filters retain particles of sand, sediment, rust from water protecting the systems that follow on the installation.

System description:

Centrifugal filters are built entirely of synthetic materials of the highest quality and can be used for drinking water.

The CENTRIFUGAL valve changes the water course in the filter to centrifugal force forcing the large particles to remain partially inferior to the vessel, depending on the size of the filtering sleeve.

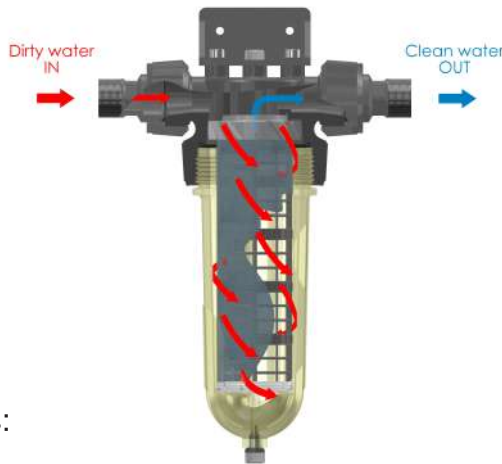

Benefits:

- high and constant flow rate
- low pressure loss
- for centrifugal filtering with hydrocyclone effect
- the possibility of purging the sediment accumulated through the bottom drain of the tap
- permanent control of sediment loading through the transparent vessel.



* Variants available with 5-20-100 micron filter pads - replaceable
150 micron - washable

* The TE model allows the Active Carbide Filter to fill the water treatment.



Centrifugal Filters



Article	Maximum flow rate (m ³ /h)	Pressure Limits (bar)	Input / Output connections	Microns	Limits of temp (°C)	Dimensions (length x diameter)
Filter NW 25 <i>Including</i> -Purging Stopper -Wrench -Sleeve 25μ	5,5	2-10	1"	20 Support sleeve 5-20-100-150 microns	4-50	15x37.7
Filter NW 32 <i>Including</i> -Purging Stopper -Wrench -Sleeve25μ	6500	2-10	1 1/4"	20 Support sleeve 5-20-100-150 microns	4-50	15x56
Filter NW 32 Active Carbon <i>Including</i> -Wrench -Stock active charcoal	0,5 Flow rate for filling with 1.70 L GRANULAR ACTIVE CARBON	2-10	1 1/4"	80	4-50	15x56
Filter NW 500 <i>Including</i> -Purging Stopper -IN OUT pressure gauges -Sleeve 25μ	20	2-10	2"	20 Support sleeve 5-20-100-150 microns	4-50	19x77 distance between connectors = 36 cm
Filter NW 650 <i>Including</i> -Purging Stopper -IN OUT pressure gauges -Sleeve25μ	25	2-10	2 1/2"	20 Support sleeve 5-20-100-150 microns	4-50	19x77 distance between connectors = 30 cm
Filter NW 800 <i>Including</i> -Purging Stopper -IN OUT pressure gauges -Sleeve25μ	30	2-10	3"	20 Support sleeve 5-20-100-150 microns	4-50	19x77 distance between connectors = 32 cm



Article	Microns	Dimensions (length x diameter) (cm)
CARTRIDGE BigBlue 10" 1-5-10-20 Microns	1-5-10-20	25x11
CARTRIDGE BigBlue 20" 1-5-10-20 Microns	1-5-10-20	51x11
CARTRIDGE PP 10" SLIM 1-5-10-20 Microns	1-5-10-20	25x6
CARTRIDGE PP 20" SLIM 1-5-10-20 Microns	1-5-10-20	51x6
SET 5 SLEEVES FILTER NW 25 5-10-20 Microns	5-10-20	-
SET 5 SLEEVES FILTER NW 25 150 MICRONS - Washable	150	-
SET 5 SLEEVES FILTER NW 32 5-10-20 Microns	5-10-20	-
SET 5 SLEEVES FILTER NW 32 150 Microns Washable	150	-
SET 5 SLEEVES FILTER NW 50-65-80 5-10-20 Microns	5-10-20	-
SET 5 SLEEVES FILTER NW 50-65-80 150 Microns Washable	150	-

IMA CONCEPT

...because water means life

EWF CA ZE 10-180 Expert Water®

**AUTOMATIC Filters with
Activ Carbon / Zeolite-Turbidex / AFM Filter Media
CLACK TC Valve - Regeneration on time**

System description

AUTOMATICALLY Expert Water filters, depending on the filter media, stop most of the sediment in water, sand, reduce the taste, color and odor of water, retain chlorine and volatile substances

Their great advantage is that **they don't have any consumables** and clean themselves, eliminating retained particles to the drain, so there is no need for frequent maintenance operations (except for annual check).

The process is assisted by a computer that makes it possible to regenerate the system to a preset number of days and one hour.

The filter media is replaced as a service operation **at 3-8 years**, depending on the quality of the raw water unless there is chlorine where the active carbon can be replaced more often (due to the chlorine content of the water).

Filtration systems are equipped with the **CLACK TC control valve** (one of the largest companies in the world) with a very high reliability.

Systems may contain as filter media

ZEOLITE with the function of Hyperfiltration - Turbidex

A zeolite of the highest quality that has the ability to retain solid suspensions by sedimentation, flocculation, physical absorption, electrostatic absorption up to 5 microns, replacing it between 4-10 years depending on the quality of the water.

Turbidex differs from other sediment filter media by

- High operating flows - low backwash flow demand
- Regeneration rarer than sand or media filters, so water saving;
- Less weight by 50% - easy to carry.

ACTIVE CARBON - is a product with a porous structure and a very large internal surface. The chemical structure of active carbon can be defined as a crude graphite form with a random amorphous structure that is very porous over a range of pore sizes, from visible cavities and from hollow to molecular size. Carbon treatment is primarily based on the phenomenon known as adsorption, in which the molecules of a liquid or gas adhere to an external or internal surface of a solid substance. The active carbon has a very large internal surface (up to 1500 m² / g), which makes it very suitable for adsorption.

The activated carbon therefore **retains chlorine, reduces oxidability, corrects the taste and smell of water, and color** - depending on the chemical composition of water.

AFM - is a revolutionary filter media made from green glass and exceed the performance of quartz and glass by filtering about 30% more organics

- Is bio - resisting and self-sterilising which mean no biofilm is formed in filter bed
- Retain particles from water until 1 micron !



Clack



AUTOMATIC filters can be used both in **industrial applications** and in **household applications** where it is necessary to install a filter for sediment reduction, chlorine removal, odor, taste, oxidation reduction including for drinking **water applications.**

www.imaconcept.ro

office@imaconcept.ro

**AUTOMATIC Filters with
Activ Carbon / Zeolite-Turbidex / AFM Filter Media
CLACK TC Valve - Regeneration on time**



Tehchnical data Systems equipped with VALVE CLACK TC	Debit Zeolit(Turbidex) / Activ Charcoal / Zeolit+Charcoal (mc / h)	Input / Output connections (inch)	Pressure (min/max) (bar)	Max temp (C)	Dimensions
					Tank+Valve (L x I x h) (cm)
EWF 10	0,8	1	2.5 - 7.5	49	17 x 80
EWF 15	1,3	1	2.5 - 7.5	49	18 x 108
EWF 20	1,7	1	2.5 - 7.5	49	22 x 108
EWF 25	1,9	1	2.5 - 7.5	49	23 x 108
EWF 35	2	1	2.5 - 7.5	49	31 x 138
EWF 50	2,9	1	2.5 - 7.5	49	31 x 138
EWF 75	3,5	1	2.5 - 7.5	49	36 x 165
EWF 100	4,4	1	2.5 - 7.5	49	36 x 165
EWF 120	5,4	1	2.5 - 7.5	49	41 x 186
EWF 140	6	1 1/4	2.5 - 7.5	49	41 x 186
EWF 160	6,5	1 1/4	2.5 - 7.5	49	46 x 186

Any configuration of any size possible. For others other than those in this list please contact us.
The above prices do not include by pass

IMA CONCEPT

...because water means life

EWS 10-160 Expert Water®

Automatic - Volume Controlled Water Softeners with
CLACK CI VALVES CABINETS - SIMPLEX - TWIN

TWIN AlternATING Systems

Softening systems consisting of 2 cages with a cationic resin tank and a salt container controlled by the same control valve capable of alternating operation (one treats water - one regenerates when needed) ensuring a flow of softened water 24/24 high-volume industrial or domestic usage.

Expert Water Water Softener retains the limestone in the water and reduces the water hardness value to 0-2 degrees depending on the quality of the inlet water. This hardness can be adjusted by additional mounting of a bypass valve.

Hard water leads to:

- stains on faucets, shower cabin, glasses
- high energy consumption because of the limestone resistance
- damage to sanitary items and heavy cleaning
- rust and degradation of colors
- clogging pipes, installations and taps
- Stone deposits in the boiler, washing machines
- Kidney stones formation

Technical and economic advantages

- Modern and compact design
- Automatic operation
- Regeneration by Water Volume at Time chosen by the user considering resin saturation
- Use in the food industry as well
- Electronic display
- Low pressure loss in operation
- Salt is consumed only if it exists water consumption - volumetric regeneration
- Salt economy to regeneration
- Non-volatile memory of history
- History:
 - daily and total volume
 - days of operation
 - maximum daily flow



Clack®



Household - Industrial - Municipal

www.imaconcept.ro

office@imaconcept.ro



Tehcnical Data	Flow	Treatment capacity @ Dose salt	Input / Output connections	Pressure (min/max)	Salt Tank Capacity	Max Temp	Dimensions	
							System/ Tank	Salt Tank
Model	(mc / h)	(Gx c @ kg)	(inch)	(bar)	(kg)	(C)	(L x l x h) (cm)	(L x l x h) (cm)
EWS 10 Cabinet	0,9	30 @ 1.2	1	2.5 - 7.5	15	49	32 x 50 x 82	-
EWS 15 Cabinet	1,4	45 @ 1.8	1	2.5 - 7.5	25	49	49 x 32 x 63	-
EWS 18 Cabinet	1,6	54 @ 2.16	1	2.5 - 7.5	25	49	49 x 32 x 81	-
EWS 20 Cabinet	1,8	60 @ 2.4	1	2.5 - 7.5	70	49	49 x 32 x 81 49 x 32 x 108	-
EWS 25 Cabinet	2	75 @ 3	1	2.5 - 7.5	70	49	49 x 32 x 108	-
EWS 25 Simplex	2	75 @ 3	1	2.5 - 7.5	100	49	23 x 108	40x40x100
EWS 35 Simplex	2,6	105 @ 4.2	1	2.5 - 7.5	100	49	31 x 138	40x40x100
EWS 50 Simplex	3,1	150 @ 6	1	2.5 - 7.5	100	49	31 x 138	40x40x100
EWS 75 Simplex	4,3	225 @ 9	1	2.5 - 7.5	100	49	36 x 165	40x40x100
EWS 100 Simplex	6	300 @ 12	1	2.5 - 7.5	100 - 140	49	36 x 165	40x40x100
EWS 120 Simplex	6,1	360 @ 14.4	1	2.5 - 7.5	140	49	41 x 186	40x40x100
EWS 140 Simplex	6,2	420 @ 16.8	1 1/4	2.5 - 7.5	140	49	41 x 186	40x40x100
EWS E 160 Simplex	6,5	480 @ 19.2	1 1/4	2.5 - 7.5	190	49	46 x 186	75 x 120



Tehcnical Data	Flow	Treatment capacity @ Dose salt	Input / Output connections	Pressure (min/max)	Salt Tank Capacity	Max Temp	Dimensions	
							/ 1 tank	Salt Tank
Model	(mc / h)	(Gxmc @kg)	(inch)	(bar)	(kg)	(C)	(L x l x h) (cm)	(L x l x h) (cm)
EWS 10 Duplex	0,9	30 @ 1.2	1	2.5 - 7.5	15	49	17 x 63	40x40x100
EWS 15 Duplex	1,4	45 @ 1.8	1	2.5 - 7.5	25	49	18 x 81	40x40x100
EWS 20 Duplex	1,8	60 @ 2.4	1	2.5 - 7.5	70	49	22 x 81	40x40x100
EWS 25 Duplex	2	75 @ 3	1	2.5 - 7.5	100	49	23 x 108	40x40x100
EWS 35 Duplex	2,6	105 @ 4.2	1	2.5 - 7.5	100	49	31 x 138	40x40x100
EWS 50 Duplex	3,1	150 @ 6	1	2.5 - 7.5	100	49	31 x 138	40x40x100
EWS 75 Duplex	4,3	225 @ 9	1	2.5 - 7.5	100	49	36 x 165	40x40x100
EWS 100 Duplex	6	300 @ 12	1	2.5 - 7.5	100 - 140	49	36 x 165	40x40x100
EWS 120 Duplex	6,1	360 @ 14.4	1	2.5 - 7.5	140	49	41 x 186	52 x 90
EWS 140 Duplex	6,2	420 @ 16.8	1 1/4	2.5 - 7.5	140	49	41 x 186	52x90
EWS 160 Duplex	6,5	480 @ 19.2	1 1/4	2.5 - 7.5	190	49	46 x 186	75 x 120

For larger configurations please contact us

IMA CONCEPT

...because water means life

EWS 10-160 Expert Expert Water®

Automatic-Volume Controlled Water Softeners
with EXPERT Valves

Household - Industrial - Municipal



Orange - Settings



Blue - Activity



Red - Regeneration



Green - History

Color screen depending on system status

Expert Water Softner retines limestone and reduces the water hardness value to 0-2 german degrees depending on the quality of the inlet water. This hardness can be adjusted by additional mounting of a bypass valve.

Hard water leads to:

- stains on faucets, shower cabin, crockery, glasses
- high energy consumption because of the limestone resistance
- damage to sanitary items and heavy cleaning
- rust and degradation of colors
- clogging pipes, installations and taps
- Stone deposits in the boiler, washing machines
- Kidney stones formation

Technical and economic advantages:

- Modern and compact design
- Automatic operation
- Regeneration by Water Volume at Time chosen by the user considering resin saturation
- Use in the food industry as well
- Electronic display
- Low pressure loss in operation
- Salt is consumed only if it exists
- water consumption - volumetric regeneration - economy
- Non-volatile memory of history
- History: - Daily volume 63 days and total
- day of operation - maximum daily flow
- **Service alarm with phone number and service center name**

TWIN Alternating Systems

Softening systems consisting of 2 cages with a cationic resin and a salt container controlled by the same control valve, capable of alternating operation (one treats water - one regenerates as needed) ensuring a flow of softened water 24/24



MULTIPLEX Systems

Softening systems consisting of 2,3,4,5 or 6 cationic resin tanks directed by a central controller according to the required flow rate in the location ensuring flow of softened water 24/24 large flows with low-volume resin tanks.



www.imaconcept.ro

office@imaconcept.ro



Tehcnical Data	Flow	Treatment capacity @ Dose salt	Input / Output connections	Pressure (min/max)	Salt Tank Capacity	Max Temp	Dimensions	
							System/ Tank	Salt Tank
Model	(mc / h)	(Gx c @ kg)	(inch)	(bar)	(kg)	(C)	(L x l x h) (cm)	(L x l x h) (cm)
EWS E 10 Cabinet	0,9	30 @ 1.2	1	2.5 - 7.5	15	49	49 x 32 x 63	-
EWS E 15 Cabinet	1,4	45 @ 1.8	1	2.5 - 7.5	25	49	49 x 32 x 81	-
EWS E 18 Cabinet	1,6	54 @ 2.16	1	2.5 - 7.5	25	49	49 x 32 x 81	-
EWS E 20 Cabinet	1,8	60 @ 2.4	1	2.5 - 7.5	70	49	49 x 32 x 81 49 x 32 x 108	-
EWS E 25 Cabinet	2	75 @ 3	1	2.5 - 7.5	70	49	49 x 32 x 108	-
EWS E 25 Simplex	2	75 @ 3	1	2.5 - 7.5	100	49	23 x 108	40x40x100
EWS E 35 Simplex	2,6	105 @ 4.2	1	2.5 - 7.5	100	49	31 x 138	40x40x100
EWS E 50 Simplex	3,1	150 @ 6	1	2.5 - 7.5	100	49	31 x 138	40x40x100
EWS E 75 Simplex	4,3	225 @ 9	1	2.5 - 7.5	100	49	36 x 165	40x40x100
EWS E 100 Simplex	6	300 @ 12	1	2.5 - 7.5	100 - 140	49	36 x 165	40x40x100
EWS E 120 Simplex	6,1	360 @ 14.4	1	2.5 - 7.5	140	49	41 x 186	60 x 110
EWS E 140 Simplex	6,2	420 @ 16.8	1 1/4	2.5 - 7.5	140	49	41 x 186	60 x 110
EWS E 160 Simplex	6,5	480 @ 19.2	1 1/4	2.5 - 7.5	190	49	46 x 186	75 x 120

For MULTIPLEX Systems please contact us



Tehcnical Data	Flow	Treatment capacity @ Dose salt	Input / Output connections	Pressure (min/max)	Salt Tank Capacity	Max Temp	Dimensions	
							System/ Tank	Salt Tank
Model	(mc / h)	(Gx c @kg)	(inch)	(bar)	(kg)	(C)	(LxIxh) (cm)	(LxIxh) (cm)
EWS E10 Duplex	0,9	30 @1.2	1	2.5 - 7.5	15	49	17 x 63	40x40x100
EWS E15 Duplex	1,4	45 @1.8	1	2.5 - 7.5	25	49	18 x 81	40x40x100
EWS E20 Duplex	1,8	60 @2.4	1	2.5 - 7.5	70	49	22 x 81	40x40x100
EWS E25 Duplex	2	75 @3	1	2.5 - 7.5	100	49	23 x 108	40x40x100
EWS E35 Duplex	2,6	105 @4.2	1	2.5 - 7.5	100	49	31 x 138	40x40x100
EWS E50 Duplex	3,1	150 @6	1	2.5 - 7.5	100	49	31 x 138	40x40x100
EWS E75 Duplex	4,3	225 @9	1	2.5 - 7.5	100	49	36 x 165	40x40x100
EWS E100 Duplex	6	300 @12	1	2.5 - 7.5	100 - 140	49	36 x 165	40x40x100
EWS E120 Duplex	6,1	360 @14.4	1	2.5 - 7.5	140	49	41 x 186	52 x 90
EWS E140 Duplex	6,2	420 @16.8	1 1/4	2.5 - 7.5	140	49	41 x 186	52x90
EWS E160 Duplex	6,5	480 @19.2	1 1/4	2.5 - 7.5	190	49	46 x 186	75 x 120

For larger configurations please contact us

Purifyo Water Softeners retines the limestone and reduces the water hardness value to 0 - 2 german degrees - depending on the quality of the inlet water. This hardness can be adjusted by additional mounting of a bypass valve.

Hard water leads to:

- stains on faucets, shower cabin, crockery, glasses
- high energy consumption because of the limestone resistance
- damage to sanitary items and heavy cleaning
- rust and degradation of colors
- clogging pipes, installations and taps
- Stone deposits in the boiler, washing machines
- Kidney stones formation

Technical and economic advantages:

- Modern and compact design
- Automatic operation
- Regeneration after Water consumption at the time chosen by the user
- Use in the food industry as well
- Electronic blue color display
- Low pressure loss in operation
- Salt is consumed only if there is water
- Volumetric regeneration
- History: - Daily volume
- Maintain settings in the event of power failure



Household and Small Industry



Technical Data	Flow	Treatment capacity @ Dose salt	Input / Output connections	Pressure (min/max)	Salt Tank Capacity	Max Temp	Dimensions	
							System/ Tank	Salt Tank
Model	(mc / h)	(Gx c @ kg)	(inch)	(bar)	(kg)	(C)	(L x l x h) (cm)	(L x l x h) (cm)
EWK 5 Cabinet	0,4	15@0.6	3/4"	2.5 - 7.5	15	49	35 x 20 x 50	-
EWK 10 Cabinet	0,9	30@1.2	3/4"	2.5 - 7.5	15	49	49 x 32 x 59	-
EWK 15 Cabinet	1,4	45@1.8	3/4"	2.5 - 7.5	25	49	49 x 32 x 77	-
EWK 18 Cabinet	1,6	54@2.2	3/4"	2.5 - 7.5	25	49	42 x 32 x 77	-
EWK 20 Cabinet	1,8	60@2.4	3/4"	2.5 - 7.5	70	49	49 x 32 x 77	-
EWK 25 Cabinet	2	75@3	3/4"	2.5 - 7.5	70	49	49 x 32 x 104	-
EWK 25 Simplex	2	75@3	3/4"	2.5 - 7.5	70	49	23 x 104	35x35x83
EWK 35 Simplex	2,6	105@4.2	3/4"	2.5 - 7.5	70	49	31 x 134	35x35x83
EWK 50 Simplex	3,1	150@6	3/4"	2.5 - 7.5	70	49	31 x 134	35x35x83
EWK 60 Simplex	3,8	180@7.2	1"	2.5 - 7.5	100	49	31 x 140	40x40x100
EWK 75 Simplex	4,3	225@9	1"	2.5 - 7.5	100	49	33 x 155	40x40x100
EWS 100 Simplex	5,5	300@12	1"	2.5 - 7.5	100	49	36 x 179	40x40x100



Technical Data	Flow	Treatment capacity @ Dose salt	Input / Output connections	Pressure (min/max)	Salt Tank Capacity	Max Temp	Dimensions	
							System/ Tank	Salt Tank
Model	(m ³ /h)	(G/c @kg)	(inch)	(bar)	(kg)	(C)	(LxIxh)(cm)	(LxIxh)(cm)
EWSK10 Duplex	0,9	30@1.2	1	2.5-7.5	15	49	25x60	20x40
EWSK15 Duplex	1,4	45@1.8	1	2.5-7.5	25	49	25x76	20x40
EWSK25 Duplex	2	75@3	1	2.5-7.5	100	49	25x105	37x37x90
EWSK50 Duplex	3,1	150@6	1	2.5-7.5	100	49	30x137	37x37x90
EWSK75 Duplex	4,3	225@9	1	2.5-7.5	100	49	33x150	40x40x100
EWSK100 Duplex	6	300@12	1	2.5-7.5	100-140	49	35x182	40x40x100

IMA CONCEPT

...because water means life

dH-Fe-Mn-NH₃

EWMix 5-140 Expert Water®

**Systems for Softening - Ammonia, Iron and Manganese removal -
Automatic-Volumetric CLACK CI VALVE**

**Household - Industrial - Municipal
TWIN Alternating Systems**

Mixed Ecomix resin systems reduce both limestone as well as iron, manganese, ammonia depending on the quality of the inlet water.

Water hard in combination with iron manganese leads to:

- stains on faucets, shower cabin, crockery, glasses
- high power consumption of the thermal power plant due to limescale coating
- damage to sanitary items and heavy cleaning
- rust and degradation of colors
- clogging pipes, installations and taps
- Stone deposits in the boiler, washing machines
- Kidney stones formation

Technical and economic advantages:

- Modern and compact design
- Automatic operation
- Regeneration by Water Volume at Time chosen by the user considering resin saturation
- Use in the food industry as well
- Electronic display
- Low pressure loss in operation
- Salt is consumed only if it exists
- water consumption - volumetric regeneration
- Salt economy to regeneration
- Non-volatile memory of history
- History: - Daily and total volume
 - day of operation - maximum daily flow

With a single installed system, solve 4 problems of water: HARDNESS - IRON - MANGANESE - AMMONIA



Clack®



www.imaconcept.ro

office@imaconcept.ro



Tehcnical Data	Flow	Treatment capacity @ Dose salt	Input / Output connections	Pressure (min/max)	Salt Tank Capacity	Max Temp	Dimensions	
							System/ Tank	Salt Tank
Model	(mc / h)	(Gx c @ kg)	(inch)	(bar)	(kg)	(C)	(L x l x h) (cm)	(L x l x h) (cm)
EWMix 5 Cabinet	0,2	10 @ 0,5	1	2.5 - 7.5	6	49	35 x 20 x 55	-
EWMix 10 Cabinet	0,4	20 @ 1	1	2.5 - 7.5	15	49	32 x 50 x 82	-
EWMix 15 Cabinet	0,6	30 @ 1,5	1	2.5 - 7.5	25	49	42 x 21 x 79	-
EWMix 18 Cabinet	0,7	36 @ 1,8	1	2.5 - 7.5	25	49	42 x 21 x 79	-
EWMix 20 Cabinet	0,8	41 @ 2	1	2.5 - 7.5	70	49	49 x 32 x 108	-
EWMix 25 Cabinet	1,1	51 @ 2,5	1	2.5 - 7.5	70	49	49 x 32 x 108	-
EWMix 25 Simplex	1,1	51 @ 2,5	1	2.5 - 7.5	100	49	23 x 108	40x40x100
EWMix 35 Simplex	1,3	76 @ 3,7	1	2.5 - 7.5	100	49	31 x 138	40x40x100
EWMix 50 Simplex	1,8	102 @ 5	1	2.5 - 7.5	100	49	31 x 138	40x40x100
EWMix 75 Simplex	2,6	153 @ 7,5	1	2.5 - 7.5	100	49	36 x 165	40x40x100
EWMix 100 Simplex	3,3	204 @ 10	1	2.5 - 7.5	100 - 140	49	36 x 165	40x40x100
EWMix 120 Simplex	4,4	255 @ 12,5	1 1/4	2.5 - 7.5	140	49	41 x 186	40x40x100
EWMix 140 Simplex	4,6	279 @ 13,7	1 1/4	2.5 - 7.5	140	49	41 x 186	40x40x100

For larger configurations please contact us



Tehnical Data	Flow	Treatment capacity @ Dose salt	Input / Output connections	Pressure (min/max)	Salt Tank Capacity	Max Temp	Dimensions	
							System/ Tank	Salt Tank
Model	(mc / h)	(Gx c @ kg)	(inch)	(bar)	(kg)	(C)	(L x l x h) (cm)	(L x l x h) (cm)
EWMix 5 Duplex	0,2	10 @ 0,5	1	2.5 - 7.5	6	49	17 x 53	40x40x100
EWMix 10 Duplex	0,4	20 @ 1	1	2.5 - 7.5	15	49	17 x 80	40x40x100
EWMix 15 Duplex	0,6	30 @ 1,5	1	2.5 - 7.5	25	49	18 x 108	40x40x100
EWMix 20 Duplex	0,8	41 @ 2	1	2.5 - 7.5	70	49	22 x 108	40x40x100
EWMix 25 Duplex	1,1	51 @ 2,5	1	2.5 - 7.5	100	49	23 x 108	40x40x100
EWMix 35 Simplex	1,3	76 @ 3,7	1	2.5 - 7.5	100	49	31 x 138	40x40x100
EWMix 50 Simplex	1,8	102 @ 5	1	2.5 - 7.5	100	49	31 x 138	40x40x100
EWMix 75 Simplex	2,6	153 @ 7,5	1	2.5 - 7.5	100	49	36 x 165	40x40x100
EWMix 100 Simplex	3,3	204 @ 10	1	2.5 - 7.5	100 - 140	49	36 x 165	40x40x100
EWMix 120 Simplex	4,4	255 @ 12,5	1 1/4	2.5 - 7.5	140	49	41 x 186	52 x 90
EWMix 140 Simplex	4,6	279 @ 13,7	1 1/4	2.5 - 7.5	140	49	41 x 186	52x 90

For larger configurations please contact us

Systems for Softening - Ammonia, Iron and Manganese removal - Automatic-Volumetric Valve EXPERT

Household - Industrial - Municipal

Mixed Ecomix resin systems reduce both limestone as well as iron, manganese, ammonia depending on the quality of the inlet water.



Orange - Settings



Blue - Activity



Red - Regeneration



Green - History

Color screen depending on system status

Water hard in combination with iron manganese leads to:

- stains on faucets, shower cabin, glasses
- high power consumption of the heaters due to limescale coating
- damage of sanitary items and heavy cleaning
- rust and degradation of colors
- clogging pipes, installations and taps
- Stone deposits in the boiler, washing machines
- Kidney stones formation

Technical and economic advantages:

- Modern and compact design
- Automatic operation
- Regeneration by Water Volume at Time chosen by the user considering resin saturation
- Use in the food industry as well
- Electronic display
- Low pressure loss in operation
- Salt is consumed only if it exists water consumption - volumetric regeneration - economy
- Saving salt at regeneration
- Non-volatile memory of history
- History: - Daily volume 63 days and total day of operation - maximum daily flow
- **Service alarm with phone number and service center name.**

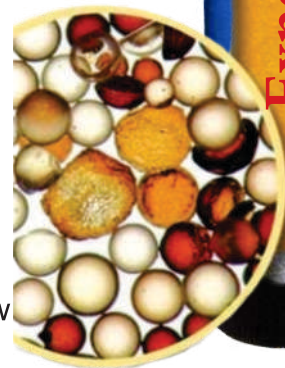

DUPLEX Alternant Systeme

Softening systems consisting of 2 cages with a cationic resin and a salt container controlled by the same control valve, capable of alternating operation (one treats water - one regenerates as needed) ensuring a flow of softened water 24/24



MULTIPLEX Systems

Softening systems consisting of 2,3,4,5 or 6 cationic resin tanks directed by a central controller according to the required flow rate in the location ensuring flow of softened water 24/24 large flows with low-volume resin tanks.



**With a single installed system, solve 4 WATER PROBLEMS
HARDNESS - IRON - MANGANESE - AMMONIA**



Tehchnical Data	Flow	Treatment capacity @ Dose salt	Input / Output connections	Pressure (min/max)	Salt Tank Capacity	Max Temp	Dimensions	
							System/ Tank	Salt Tank
Model	(mc / h)	(Gx c @ kg)	(inch)	(bar)	(kg)	(C)	(L x l x h) (cm)	(L x l x h) (cm)
EWMix E 5 Cabinet	0,2	10 @ 0,5	1	2.5 - 7.5	6	49	35 x 20 x 55	-
EWMix E 10 Cabinet	0,4	20 @ 1	1	2.5 - 7.5	15	49	32 x 50 x 82	-
EWMix E 15 Cabinet	0,6	30 @ 1,5	1	2.5 - 7.5	25	49	42 x 21 x 67	-
EWMix E 20 Cabinet	0,8	41 @ 2	1	2.5 - 7.5	70	49	49 x 32 x 108	-
EWMix E 25 Cabinet	1,1	51 @ 2,5	1	2.5 - 7.5	70	49	49 x 32 x 108	-
EWMix E 25 Simplex	1,1	51 @ 2,5	1	2.5 - 7.5	100	49	23 x 108	40x40x100
EWMix E 35 Simplex	1,3	76 @ 3,7	1	2.5 - 7.5	100	49	31 x 138	40x40x100
EWMix E 50 Simplex	1,8	102 @ 5	1	2.5 - 7.5	100	49	31 x 138	40x40x100
EWMix E 75 Simplex	2,6	153 @ 7,5	1	2.5 - 7.5	100	49	36 x 165	40x40x100
EWMix E 100 Simplex	3,3	204 @ 10	1	2.5 - 7.5	100 - 140	49	36 x 165	40x40x100
EWMix E 120 Simplex	4,4	255 @ 12,5	1 1/4	2.5 - 7.5	140	49	41 x 186	40x40x100
EWMix E 140 Simplex	4,6	279 @ 13,7	1 1/4	2.5 - 7.5	140	49	41 x 186	40x40x100

For larger configurations please contact us



Technical Data	Flow	Treatment capacity @ Dose salt	Input / Output connections	Pressure (min/max)	Salt Tank Capacity	Max Temp	Dimensions	
							System/ Tank	Salt Tank
Model	(mc / h)	(Gx c @ kg)	(inch)	(bar)	(kg)	(C)	(L x l x h) (cm)	(L x l x h) (cm)
EWMix E 5 Duplex	0,2	10 @ 0,5	1	2.5 - 7.5	6	49	17 x 53	40x40x100
EWMix E 10 Duplex	0,4	20 @ 1	1	2.5 - 7.5	15	49	17 x 80	40x40x100
EWMix E 15 Duplex	0,6	30 @ 1,5	1	2.5 - 7.5	25	49	18 x 108	40x40x100
EWMix E 20 Duplex	0,8	41 @ 2	1	2.5 - 7.5	70	49	22 x 108	40x40x100
EWMix E 25 Duplex	1,1	51 @ 2,5	1	2.5 - 7.5	100	49	23 x 108	40x40x100
EWMix E 35 Duplex	1,3	76 @ 3,7	1	2.5 - 7.5	100	49	31 x 138	40x40x100
EWMix E 50 Duplex	1,8	102 @ 5	1	2.5 - 7.5	100	49	31 x 138	40x40x100
EWMix E 75 Duplex	2,6	153 @ 7,5	1	2.5 - 7.5	100	49	36 x 165	40x40x100
EWMix E 100 Duplex	3,3	204 @ 10	1	2.5 - 7.5	100 - 140	49	36 x 165	40x40x100
EWMix E 120 Duplex	4,4	255 @12,5	1 1/4	2.5 - 7.5	140	49	41 x 186	52 x 90
EWMix E 140 Duplex	4,6	279 @13,7	1 1/4	2.5 - 7.5	140	49	41 x 186	52x 90

For larger configurations please contact us

IMA CONCEPT

...because water means life

NO_3SO_4

EWNO3 5-140 Expert Water®

Volumetric-Automatic Denitrification Systems
with Valve with Valve CLACK SUA CI / EI

Household - Industrial - Municipal

The resin systems for reducing nitrates and sulphates from water.

Water with big content of nitrate is not drinkable and can cause diseases especially for newborns.

By boiling the water the nitrate turns into nitrites - carcinogenic compounds

In order to bring nitrates out of the water to normal limits, it is necessary to install an ion exchange resin system that is regenerated with saline solution.

Systems are fully automated to reduce concentration nitrates and sulphates in water, but increase the amount of chlorine.

Technical and economic advantages:

- Modern and compact design
- Automatic operation
- Regeneration by Volume of water used at one hour chosen by the user
- Use in the food industry as well
- Electronic display
- Low pressure loss in operation
- Salt is consumed only if it exists water consumption - volumetric regeneration
- Salt economy to regeneration
- Non-volatile memory of history
- History: - Daily volume 63 days and total
- day of operation - maximum daily flow

DUPLEX Alternant System

Systems for denitrification of water composed of two ion exchange resin tanks and a salt vessel controlled by the same control valve, capable of alternating operation (one treats water - one regenerates as needed) ensuring a flow of water



Clack®

www.imaconcept.ro

office@imaconcept.ro



Tehnickal Data	Flow	Treatment capacity @ Dose salt	Input / Output connections	Pressure (min/max)	Salt Tank Capacity	Max Temp	Dimensions	
							System/ Tank	Salt Tank
Model	(mc / h)	(Gx c @ kg)	(inch)	(bar)	(kg)	(C)	(L x l x h) (cm)	(L x l x h) (cm)
EWNO3 5 Cabinet	0,4		1	2.5 - 7.5	6	49	35 x 20 x 55	-
EWNO3 10 Cabinet	0,9		1	2.5 - 7.5	15	49	32 x 50 x 82	-
EWNO3 15 Cabinet	1,4		1	2.5 - 7.5	25	49	42 x 21 x 79	-
EWNO3 20 Cabinet	1,8		1	2.5 - 7.5	70	49	49 x 32 x 108	-
EWNO3 25 Cabinet	2		1	2.5 - 7.5	70	49	49 x 32 x 108	-
EWNO3 25 Simplex	2		1	2.5 - 7.5	100	49	23 x 108	40x40x100
EWNO3 35 Simplex	2,6		1	2.5 - 7.5	100	49	31 x 138	40x40x100
EWNO3 50 Simplex	3,1		1	2.5 - 7.5	100	49	31 x 138	40x40x100
EWNO3 75 Simplex	4,3		1	2.5 - 7.5	100	49	36 x 165	40x40x100
EWNO3 100 Simplex	6		1	2.5 - 7.5	100 - 140	49	36 x 165	40x40x100
EWNO3120 Simplex	6,1		1 1/4	2.5 - 7.5	140	49	41 x 186	40x40x100
EWNO3 140 Simplex	6,2		1 1/4	2.5 - 7.5	140	49	41 x 186	40x40x100

For larger configurations please contact us



Tehcnical Data	Flow	Treatment capacity@ Dose salt	Input / Output connections	Pressure (min/max)	Salt Tank Capacity	Max Temp	Dimensions	
							System/ Tank	Salt Tank
Model	(mc / h)	(Gx c @kg)	(inch)	(bar)	(kg)	(C)	(Lx l x h) (cm)	(Lx l x h) (cm)
EWNO3 5 Duplex	0,4		1	2.5 - 7.5	6	49	17 x 53	40x40x100
EWNO3 10 Duplex	0,9		1	2.5 - 7.5	15	49	17x80	40x40x100
EWNO3 15 Duplex	1,4		1	2.5 - 7.5	25	49	18 x 108	40x40x100
EWNO3 20 Duplex	1,8		1	2.5 - 7.5	70	49	22 x 108	40x40x100
EWNO3 25 Duplex	2		1	2.5 - 7.5	100	49	23 x 108	40x40x100
EWNO3 35 Duplex	2,6		1	2.5 - 7.5	100	49	31 x 138	40x40x100
EWNO3 50 Duplex	3,1		1	2.5 - 7.5	100	49	31 x 138	40x40x100
EWNO3 75 Duplex	4,3		1	2.5 - 7.5	100	49	36 x 165	40x40x100
EWNO3 100 Duplex	6		1	2.5 - 7.5	100 - 140	49	36 x 165	40x40x100
EWNO3 120 Duplex	6,1		1 1/4	2.5 - 7.5	140	49	41 x 186	52 x 90
EWNO3 140 Duplex	6,2		1 1/4	2.5 - 7.5	140	49	41 x 186	52x 90

For larger configurations please contact us

IMA CONCEPT

...because water means life

NO_3SO_4

EWNO3 5-140 Expert

Expert Water®

Volumetric-Automatic Denitrification Systems with EXPERT Valves

Household - Industrial - Municipal

The resin systems for reducing nitrates and sulphates from water.

Water with big content of nitrate is not drinkable and can cause diseases especially for newborns.

By boiling the water the nitrate turns into nitrites - carcinogenic compounds

In order to bring nitrates out of the water to normal limits, it is necessary to install an ion exchange resin system that is regenerated with saline solution.

Systems are fully automated to reduce concentration nitrates and sulphates in water, but increase the amount of chlorine.

Technical and economic advantages:

- Modern and compact design
- Automatic operation
- Regeneration by Volume of water used at one hour chosen by the user
- Use in the food industry as well
- Electronic display
- Low pressure loss in operation
- Salt is consumed only if it exists water consumption - volumetric regeneration
- Salt economy to regeneration
- Non-volatile memory of history
- History: - Daily volume 63 days and total
 - day of operation - maximum daily flow
- **Service alarm with phone number and center name service**



Orange - Settings



Blue - Activity



Red - Regeneration



Green - History

Color screen depending on system status



DUPLEX Alternan Systems

Systems for denitrification of water composed of two ion exchange resin tanks and a salt vessel controlled by the same control valve, capable of alternating alternating operation (one treats water - one regenerates as needed) ensuring a flow of water treated 24/24



MULTIPLEX Systems

Systems for denitrification of water composed of 2,3,4,5 or 6 cationic resin tanks directed by a central controller depending on the flow required in location providing flux treated water 24/24 at high debits with resin tanks reduced in volume.



www.imaconcept.ro

office@imaconcept.ro



Tehcnical Data	Flow	Treatment capacity @ Dose salt	Input / Output connections	Pressure (min/max)	Salt Tank Capacity	Max Temp	Dimensions	
							System/ Tank	Salt Tank
Model	(mc / h)	(Gx c @kg)	(inch)	(bar)	(kg)	(C)	(L x I x h) (cm)	(L x I x h) (cm)
EWNO3 E 5 Cabinet	0,4		1	2.5 - 7.5	6	49	35 x20 x55	-
EWNO3 E 10 Cabinet	0,9		1	2.5 - 7.5	15	49	32 x 50 x 82	-
EWNO3 E 15 Cabinet	1,4		1	2.5 - 7.5	25	49	42 x 21 x 67	-
EWNO3 E 20 Cabinet	1,8		1	2.5 - 7.5	70	49	49 x 32 x 108	-
EWNO3 E 25 Simplex	2		1	2.5 - 7.5	70	49	49 x 32 x 108	-
EWNO3 E 25 Simplex	2		1	2.5 - 7.5	100	49	23 x 108	40x40x100
EWNO3 E 35 Simplex	2,6		1	2.5 - 7.5	100	49	31 x 138	40x40x100
EWNO3 E 50 Simplex	3,1		1	2.5 - 7.5	100	49	31 x 138	40x40x100
EWNO3 E 75 Simplex	4,3		1	2.5 - 7.5	100	49	36 x 165	40x40x100
EWNO3 E 100 Simplex	6		1 1/4	2.5 - 7.5	100 - 140	49	36 x 165	40x40x100
EWNO3 E 120 Simplex	6,1		1 1/4	2.5 - 7.5	140	49	41 x 186	40x40x100
EWNO3 E 140 Simplex	6,2		1 1/4	2.5 - 7.5	140	49	41 x 186	40x40x100

For larger configurations please contact us



Tehnrical Data	Flow	Treatment capacity @ Dose salt	Input / Output connections	Pressure (min/max)	Salt Tank Capacity	Max Temp	Dimensions	
							System/ Tank	Salt Tank
Model	(mc / h)	(Gx c @ kg)	(inch)	(bar)	(kg)	(C)	(L x l x h) (cm)	(L x l x h) (cm)
EWNO3 E 5 Duplex	0,4		1	2.5 - 7.5	6	49	17 x 53	40x40x100
EWNO3 E 10 Duplex	0,9		1	2.5 - 7.5	15	49	17 x 80	40x40x100
EWNO3 E 15 Duplex	1,4		1	2.5 - 7.5	25	49	18 x 108	40x40x100
EWNO3 E 20 Duplex	1,8		1	2.5 - 7.5	70	49	22 x 108	40x40x100
EWNO3 E 25 Duplex	2		1	2.5 - 7.5	100	49	23 x 108	40x40x100
EWNO3 E 35 Duplex	2,6		1	2.5 - 7.5	100	49	31 x 138	40x40x100
EWNO3 E 50 Duplex	3,1		1	2.5 - 7.5	100	49	31 x 138	40x40x100
EWNO3 E 75 Duplex	4,3		1	2.5 - 7.5	100	49	36 x 165	40x40x100
EWNO3 E 100 Duplex	6		1 1/4	2.5 - 7.5	100 - 140	49	36 x 165	40x40x100
EWNO3 E 120 Duplex	6,1		1 1/4	2.5 - 7.5	140	49	41 x 186	52 x 90
EWNO3 E 140 Duplex	6,2		1 1/4	2.5 - 7.5	140	49	41 x 186	52x 90

For larger configurations please contact us

IMA CONCEPT

...because water means life

H₂S + Fe + Mn

EWH2S 30-100 ExpertWater®

**Automatic System EWH2S for Desulphurisation - Regeneration on time -
Desulphurisation, Iron, Manganese Removal**

Household - Industrial - Municipal

Unique system in Romania

It's a 3 in 1 system. With it you solve the problem of iron, manganese, and hydrogen sulphide.

It uses state-of-the-art technologies in the field of water treatment - compressed air chamber and catalytic environment.

No air compressor is used and no consumables.

In the first stage, iron, manganese and hydrogen sulfide are oxidized, function assured by the compressed air chamber through which water enters the system, and in the second stage the elements are retained on the catalytic medium. Regeneration of the system consists of replacing the air chamber and cleaning the catalytic environment - this is automatically done by the latest generation intelligent control valve adapted to carry out all stages of regeneration.



www.imaconcept.ro

office@imaconcept.ro

Automatic System EWH2S for Desulphurisation - Regeneration on time -
Desulphurisation, Iron, Manganese Removal

Household - Industrial - Municipal



Tehnical Data	Flow	Treatment capacity @ Dose salt	Input / Output connections	Pressure (min/max)	Salt Tank Capacity	Max Temp	Dimensions	
							System/ Tank	Salt Tank
Model	(m ³ /h)	(Gx c @kg)	(inch)	(bar)	(kg)	(C)	(Lx l x h) (cm)	(Lx l x h) (cm)
EWH2S 30	1,2		1	2.5 - 7.5	100	49	31 x 138	40x40x100
EWH2S 50	1,8		1	2.5 - 7.5	100	49	31 x 138	40x40x100
EWH2S 75	2,6		1	2.5 - 7.5	100	49	36 x 165	40x40x100
EWH2S 100	3,2		1	2.5 - 7.5	100 - 140	49	36 x 165	40x40x100

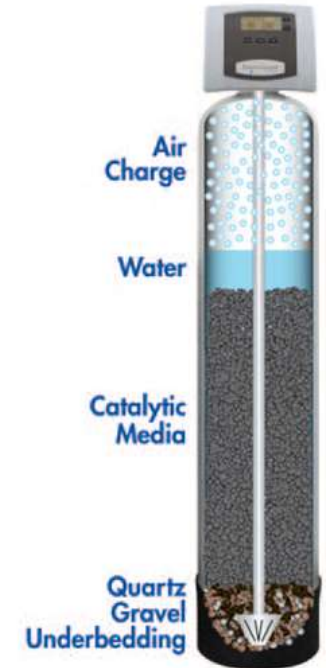

For larger configurations please contact us

IMA
CONCEPT

...because water means life

H₂S+Mn+Fe+dH+NH₃

EWH₂SMIX 30-100

Expert Water[®]

**Automatic System EWH₂SMIX for Desulphurisation - Regeneration on time -
Desulphurisation, Iron, Manganese Removal, Softening**

Household - Industrial - Municipal

Unique system in Romania

It's a 5 in 1 system. This solves the problem of iron, manganese, hydrogen sulphide, hardness and ammonia.

It uses state-of-the-art water treatment technologies - compressed air chamber and mixed ion exchange resins.

No compressor for air injection is used and the only consumable is the pastille salt for regeneration of the resin.

In the first stage, iron, manganese and hydrogen sulfide are oxidized, function assured by the compressed air chamber through which water enters the system, and in the second stage the elements are retained on the cationic resin. Regeneration of the system consists of replacing the air chamber and regenerating the ion exchange resins - these are automatically done by the latest generation intelligent control valve adapted to perform all stages of regeneration.



www.imaconcept.ro
office@imaconcept.ro

**Automatic System EWH₂SMIX for Desulphurisation - Regeneration on time -
Desulphurisation, Iron, Manganese Removal, Softening
Household - Industrial - Municipal**



Date tehnice	Debit	Capacitate tratare @ Doza sare	Conexiuni intrare- iesire	Presiune (min/max)	Capacitate rezervor sare	Temp max	Dimensiuni	
							/1 tanc	Vas sare
Model	(mc/h)	(?Gxmc@kg)	(inch)	(bar)	(kg)	(?C)	(LxLxh)(cm)	(LxLxh)(cm)
EWH₂S 30	1,2		1	2.5 - 7.5	100	49	31 x 138	40x40x100
EWH₂S 50	1,8		1	2.5 - 7.5	100	49	31 x 138	40x40x100
EWH₂S 75	2,6		1	2.5 - 7.5	100	49	36 x 165	40x40x100
EWH₂S100	3,2		1	2.5 - 7.5	100 - 140	49	36 x 165	40x40x100

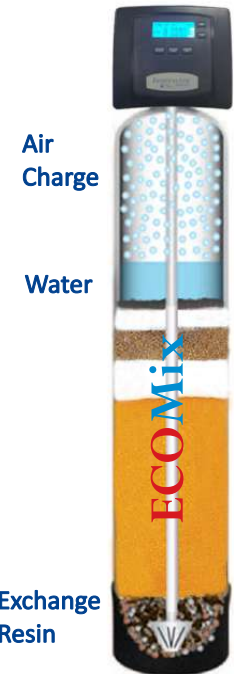

For larger configurations please contact us

Softening Components and Automatic Filters



Article	Max flow (l/h)	Pressure limits (bar)	Input / Output connections	Finete filtering (microns)	Temp limits (°C)	Dimensions (length x diameter)
Time Controlled CLACK 1" VALVE						
(Valve - DLFC - Transformer - Connectors 1") CLACK SUA						
Valve Softening CLACK CI-1"- Volume						
(Valve - DLFC - Transformer - Connectors) CLACK SUA						
Valve Softening CLACK EXPERT -1" Volume						
(Valve - DLFC - Injector - Transformer - Connectors)*** Extended Meniu CLACK SUA						
Twin Alternating CLACK VALVE 1"						
(Valve - DLFC - Injector - Transformer - Connectors) Producer: CLACK SUA						
By Pass Valve Clack 1"						
Transformer Valve Clack						
Set Connectors Clack 1"						

CLACK VALVES SPARE PARTS



Article	Image Nr.	CODE
WS1 PCB ACT REPLACE	9	3108 CI
EXPERT PCB ALT REPLACE	9	
WS1 MOTOR	1	V3107
DRIVE CAP AS4	2	C3004
WS1 SPACER STACK ASSEMBLY	3	V3005
WS1 PISTON DOWNFLOW ASY	4	V3174
WS1 REGENERANT PISTON	5	V3011
WS1 METER ASY	6	V3003
SERVICE WRENCH		V3193
IN OUT HEAD TWIN CLACK	8	1191

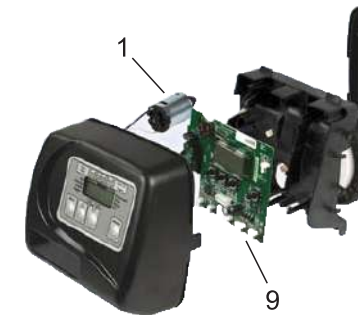
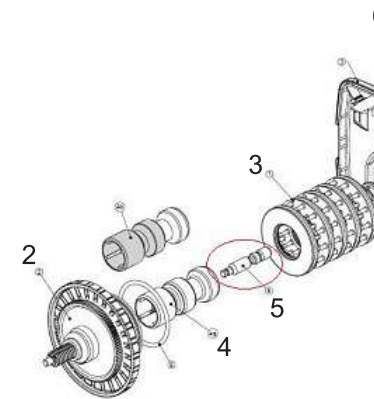

Filtering states

Article	Price per	Reduce	Microns
Gravel 3-5 mm	1 L		
- For the lower part			
Gravel 0.8 - 1.2 mm	1 L		
- Amestec sau Filtrare mecanica 50μ			
Resin ECOMIX	1 L	dH / Fe / Mn / NH4	
- Retain Hardness-Iron-Manganese-Ammonia-Oxidability			
Activ Carbon	1 L	Cl / Color / Sediment	60
Pyrolox	1 L	Fe / Mn / H2S	
- Retain Iron, Manganese, Hydrogen sulfide			
AFM Filter Media	1 L		1
Turbidex	1 L	Sediment	5
- Mechanical filtration 5μ			
Aqua DOL	1 L	Increase pH	
Softening Resin	1 L	dH	
Softening Resin	1 L	dH	
DOW Chemicals			
Resin For Denitrification	1 L		

Description of the system :

Provides demineralised water produced on the reverse osmosis principle.

Reduces the mineral salt concentration in the water to 96-99%.

*Only use **water free of Chlorine, Hardness, Iron, Manganese.***

System design

Complete wired unit, pre-assembled, ready to install, cable (3 m):

- Fully automated operation - stops operation when tank is full;
- Stainless steel or aluminum base frame with stainless or forex front panel where flow meters, pressure gauges and conductivity monitor are located which instantly measure the conductivity of the product permeate;
- High-pressure pump with low-noise;
- Osmotic spiral membrane with increased energy efficiency;
- INOX pressure vessels;
- Water supply valve, sampling probe, solenoid inlet electrode, low pressure sensor for the water, vibration resistant flowmeter, manometer for permeate pressure pumps, permeate flow adjustment, concentrate and recirculation valve - the function of recirculation increases the recovery rate.

Optionally, systems can be equipped with - *Microprocessor control system, high pressure pump control, fully automated monitoring and system control. Display with 2 lines of text for viewing the RO process and displaying the operating status, displays output conductivity, input conductivity, low water alarm, high conductivity alarm.*



The systems can be used in **industrial applications** and **domestic applications** where water conductivity is increased.

Systems can be customized on request
(dimensions - options - equipment)-
ASK FOR ANY CONFIGURATIONS

Tehcnical Data	Flow	Min-Max Rejection Coefficient	Recovery	Work pressure	Nr Membranes / Type	Voltage	Intake	Water Pressure Input	Water temp (min- max)	Environ ment Temp max	Height	Width	Depth	Weight (approx - empty)
Model	(l/h)	(%)	(%)	(bar)		(V/Hz)	(Kw)	(bar)	(C)	(C)	(mm)	(mm)	(mm)	(kg)
EWRO 250	250	96-99	50-75	6 -- 12	1 x 4040	220 / 50	0.55	2 – 6	5 – 35	40	1250	500	300	60
EWRO 500	500	96-99	50-75	6 -- 12	2 x 4040	220 / 50	0.75	2 – 6	5 – 35	40	1250	500	300	75
EWRO 750	750	96-99	50-75	6 -- 12	3 x 4040	3x400 / 50	1.5	2 – 6	5 – 35	40	1550	750	550	100
EWRO 1000	1000	96-99	50-75	6 -- 12	3 x 4040	3x400 / 50	1.5	2 – 6	5 – 35	40	1550	660	700	115
EWRO 1250	1250	96-99	50-75	6 -- 12	5 x 4040	3x400 / 50	2.2	2 – 6	5 – 35	40	1550	660	700	195
EWRO 1500	1500	96-99	50-75	6 -- 12	6 x 4040	3x400 / 50	3	2 – 6	5 – 35	40	1650	2550	135	230
EWRO 2000	2000	96-99	50-75	6 -- 12	8 x 4040	3x400 / 50	3	2 – 6	5 – 35	40	1650	2550	150	270
EWRO 2500	2500	96-99	50-75	6 -- 12	10 x 4040	3x400 / 50	4	2 – 6	5 – 35	40	1650	3550	180	320
EWRO 3000	3000	96-99	50-75	6 -- 12	12 x 4040	3x400 / 50	4	2 – 6	5 – 35	40	1650	3550	195	390
EWRO 4300	4300	96-99	50-75	6 -- 12	3 x 8040	3x400 / 50	5.5	2 – 6	5 – 35	40	1900	2800	750	450
EWRO 5400	5400	96-99	50-75	6 -- 12	4 x 8040	3x400 / 50	5.5	2 – 6	5 – 35	40	1900	2800	750	500
EWRO 7000	7000	96-99	50-75	6 -- 12	5 x 8040	3x400 / 50	7.5	2 – 6	5 – 35	40	1900	3800	750	600
EWRO 8000	8000	96-99	50-75	6 -- 12	6 x 8040	3x400 / 50	11	2 – 6	5 – 35	40	1900	3800	800	700
EWRO 9500	9500	96-99	50-75	6 -- 12	7 x 8040	3x400 / 50	11	2 – 6	5 – 35	40	1900	4800	800	800
EWRO 12000	12000	96-99	50-75	6 -- 12	9 x 8040	3x400 / 50	11	2 – 6	5 – 35	40	1900	4800	800	900

Industrial Reverse Osmosis Components

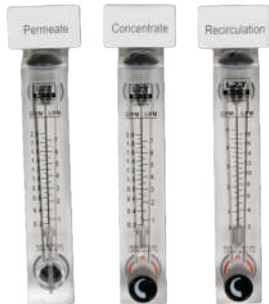

Artide	Input / output connections	Finete filtering (microns)	Temp Limits (°C)	Dimensions (length x diameter)
RO Membrane ULP 4040 - Expert Water		0.001		100X10
RO Membrane Case 4040				
CAP FOR Membrane Case 4040				
O-ring FOR Membrane Case Cap 4040				
FLOWMETER RO 10 GPM				
FLOWMETER RO 10 GPM WITH ADJUSTMENT				
FLOWMETER RO 2 GPM				
FLOWMETER RO 2 GPM WITH ADJUSTMENT				
FLOWMETER RO 5 GPM				
FLOWMETER RO 5 GPM WITH ADJUSTMENT				

Industrial Reverse Osmosis Components



Article	Input / output connections	Finete filtering (microns)	Temp Limits (°C)	Dimensions (length x diameter)
MANOMETER PANEL D63 0-25 BAR				
RO CONDUCTIVITY MONITOR				
LOW Pressure Switch				
STAINLESS STEEL FRONT PANNEL FOR RO 250-500 L/H				
STAINLESS STEEL FRONT PANNEL FOR RO 750 - 2500 L/H				
STAINLESS STEEL FRAME FOR RO 250-500 L/H				
STAINLESS STEEL FRAME FOR RO 750 - 2500 L/H				

Industrial Reverse Osmosis Components



Article	Input / output connections	Microns	Temp Limits (°C)	Dimensions (length x diameter)
MOTOR 220V - PUMP EWRO 500 0.75KW				
MOTOR 220V - PUMP EWRO 250 - 0.55KW				
PUMP RO INDUSTRIAL 500L				
PUMP RO INDUSTRIAL 250L				
PUMP COVER RO 250-500				
PUMP ADAPTER - MOTOR RO EWRO 250-500				
GRUNDFOS PUMP CMI 3-12 OR SIMILAR				
Complete RO Controller BOX for 750 - 2500 l/h RO with Conductivity monitor				
Complete RO Controller BOX for 250-500 l/h RO with Conductivity monitor				

We are all aware of how important it is to drink healthy and safe water.

For this you no longer need to stand in queues, carve cans, and occupy the space in your house with plastic cans.

You can have very good water quality directly on your kitchen.

Expert Water Reverse Osmosis Systems they use the latest news in the field bringing plus water quality.

Used extensively in certain industries and hospitals, these systems have increasingly begun to be used in the domestic field, especially due to the increased water quality, reliability and high alloy components in this system!

Among the compounds diminished in water are: arsenic, barium, selenium, ammonium, bicarbonates, bromides, free chlorine, chlorides, magnesium, sodium, sulfates, tannins, zinc, aluminum, turbidity, unpleasant taste and smell.

Reverse osmosis system has a very simple construction and occupies a limited space under the sink.

. **A tap is installed on the sink**, separate from the existing one, which will provide the highest quality flat water we use to prepare food, tea, coffee, and even more importantly for drinking.

Supplies costs are much lower than the purchase of commercial still water!

It will provide the best quality water and you will have the certainty of this all the time being your own equipment!



Stage 1: - Sediment filter (5 microns), eliminates mechanical impurities larger than 5 microns: sand, rust, mud, etc.

Stage 2: - Activated carbon filter, improves the taste, smell and color of the water

Stage 3: - Sediment filter (1 micron), eliminates mechanical impurities larger than 1 micron.

Stage 4: - Osmotic membrane - the most important element of the RO system. The membrane has the dimension of filtering 0.001 microns and removes organic and inorganic contaminants, dissolved solids, heavy metals, nitrates, phenols

Stage 5: - Active carbon filter removes gases and volatile substances from water, enriches the taste and smell of water.

Stage 6: - Ultimate remineralizing granule filter - on the same principle that controlled minerals are reintroduced.



Article		Production capacity (l / h)	Water pressure (min / max bar)	Water temperature (°C)	Dimensions (length x width x height)
Ultrafiltration System		30 l/h	1 - 5	4-49	16x35x52
House-Office Purifier Reverse Osmosis 6 Steps	Reverse	8	3-7	5-35	Body: 16x35x52 Tank: 30x35
House-Office Purifier Reverse Osmosis 6 Steps + Booster Pump	Reverse	11	1.5 - 7	5-35	Body: 16x35x52 Tank: 30x35
Purifier Reverse Osmosis 6 Steps - 400 gpd - 60 l/h	Direct Flow	60	1.5 - 7	5-35	Body: 16x35x65
Produces 1440 Liters / 24 Hours					
1 membrane 400 gpd					
Purifier Reverse Osmosis 6 Steps - 800 gpd - 120 l/h	Direct Flow	120	1.5 - 7	5-35	Body: 16x35x70
Produces 2880 Liters / 24 Hours					
2 membranes 400 gpd					

Purifying options & Purifying Spare Parts House and Office RO



UV 6 W Sterilizer

Anihilates Bacteria from Water



In-line Alkaline Cartridge

Increases the pH of the water



Active Carbon 10 " Cartridge



Active Carbon In-Line Cartridge



In Line Denitrification Cartridge



In Line Remineralization Cartridge



In Line Demineralization Cartridge



Cartridge PP 10" - 1 Microns



Cartridge PP 10" - 5 Microns



RO Membrane 50 gpd



RO Membrane 100 gpd



RO Membrane 400 gpd



RO Membrane 4040 ULP 5- 12 bars working pressure 250 l / h - 2400 gpd

Article	Production capacity (l / h)	Water pressure (min / max bar)	Water temperature (°C)	Dimensions (length x width x height)
UV 6 W Sterilizer <i>Anihilates Bacteria from Water</i>	120	0 - 8	5-35	26x5
In-line Alkaline Cartridge <i>Increases the pH of the water</i>		0 - 10	5 - 35	
Active Carbon 10 " Cartridge				
Active Carbon In-Line Cartridge				
In Line Denitrification Cartridge				
In Line Remineralization Cartridge				
In Line Demineralization Cartridge				
Cartridge PP 10" - 1 Microns				
Cartridge PP 10" - 5 Microns				
RO Membrane 50 gpd				
RO Membrane 100 gpd				
RO Membrane 400 gpd				



Article	
3 way RO Faucet	
<i>It takes over the functions of the classic Hot Water-Cold Water faucet and RO faucet</i>	
Simple RO Faucet	
Double RO Faucet	
Membrane Osmosis Case 50-75 GPD	
Membrane Osmosis Case 400 GPD	
In Line - Refill Cartridge	
Filter Case 1/4"	
Refill 10" Cartridge	

Purifier Components for House & Office



Cartridge Clamp 50-50 mm



Cartridge Clamp 50-60 mm



Connector (L) 6 mm IN-IN-OUT



Connector (T) 6 mm IN-IN-OUT



Elbow Connector 1/4"6mm



Check Valve 6 mm tube



Straight Connector 1/4" 6 mm

Article	Production capacity (l / h)	Water pressure (min / max bar)	Water temperature (°C)	Dimensions (length x width x height)
Cartridge Clamp 50-50 mm				
Cartridge Clamp 50-60 mm				
Connector (L) 6 mm IN-IN-OUT				
Connector (T) 6 mm IN-IN-OUT				
Elbow Connector 1/4"6mm				
Check Valve 6 mm tube				
Straight Connector 1/4" 6 mm				

Purifier Components for House & Office



Article	Production capacity (l/h)	Water pressure (min / max bar)	Water temperature (°C)	Dimensions (length x width x height)
Straight Connector 1/8" 6 mm				
Connector 6 mm - 6 mm				
Connector 6 mm - 10 mm				
T - Connector 6 mm tube				
T - Connector 6 mm tube - 1/4 thread				
VALVE 4 WAYS				
6 mm tube				
10 mm tube				

Purifier Components for House & Office



Inlet Connection kit 1/2''-1/2'' -1/4''



Drain Connector



OSMOSIS PUMP 400 GPD



OSMOSIS PUMP 50-75 GPD



OSMOSIS PUMP TRANSFORMER 50-75 GPD



OSMOSIS PUMP TRANSFORMER 400 GPD

Article	Production capacity (l / h)	Water pressure (min / max bar)	Water temperature (°C)	Dimensions (length x width x height)
Inlet Connection kit 1/2''-1/2'' -1/4''				
Drain Connector				
OSMOSIS PUMP 400 GPD				
OSMOSIS PUMP 50-75 GPD				
OSMOSIS PUMP TRANSFORMER 50-75 GPD				
OSMOSIS PUMP TRANSFORMER 400 GPD				

Purifier Components for House & Office



Flow Restrictor 300-400-800-1100



TAP ON HOSE 6 mm - 6 mm



TANK TAP 1/4" 6 mm



Splitter 6 mm



OSMOSIS TANK 3,2 GALLONS

OSMOSIS TANK 2,6 GALLONS

Reverse Osmosis Storage tank available 4 Gallons and 11 Gallons

Purifier Components for House & Office



High Pressure Valve



Low Pressure Valve



Solenoid Valve



Filter RO Wrench



Features :

THE SYSTEM PROVIDES:

- Reverse Osmosis PURIFIED WATER
- Temperature setting FOR HOT AND COLD
- Compact monoblock system
- LCD screen
- refrigeration with freon compressor

WATER TREATMENT IN THE SYSTEM:

1. 5 micron sediment filter: eliminates impurities in water larger than 5 microns (sediment, rust, mud, etc.)
2. Active carbon filter retains chlorine and improves the taste, smell and color of the water;
3. 1 micron sediment filter: remove water impurities larger than 1 micron;
4. Semi-permeable RO membrane with 0.001 micron : removes organic and anorganic contaminants, dissolved solids, heavy metals, nitrates, phenols, radioactive elements;
5. Active carbon filter: eliminates gases and volatile substances in water, enriches the taste and smell of water;
6. Remineralization cartridge: reintroduces the necessary minerals into the water;
7. UV Sterilizer - removes bacteria from water - OPTIONAL

Suitable for: Municipal water or well water

Water production capacity (l / h): 7-10 l / h

Power supply / power (V / Hz / W): 220-240 V

Heating capacity (L / H): 6 l / h at 90-95 ° C

Cooling capacity (L / H): 2 l / h at 7-10 ° C

Net weight: 25 kg

Water pressure used: 2 - 5 bar

Dimensions:

- On the Floor: 40 x 28 cm h: 115 cm
- On the Counter: 40 x 28 cm h: 150 cm



**YOU WON'T NEED
Packaging Plastic - Transport - Supply - Storage space**

RIO II - Double Body Alkaline Water System

- Advantages of the system:
- The new platinum and titanium plates: with integrated slots, according to a patented technology.
- 300 watts: Power enough to ionize the water of any house.
- SMPS electric system: reduces the incidence and increases the accuracy of ionization.
- Displays pH, filter life.
- Filter and revitalize the water until it is ionized!
- Do not add sulphites to the water - do not use water that can not be cleaned with the system!
- Elegance is in line with the top performance of the system.

Ionized alkaline water is also referred to as "living water" or "structured water", "anti-aging water", "energy water" because it has three great qualities:

- help blood keep its alkalinity and neutralize acid deposits, has antioxidant effect;
- can eliminate free radicals responsible for increasing the risk of disease and inhibits other oxidation reactions;
- has a 3 times smaller structure that allows it to better hydrate the body, the cells.
- It is a water that reaches the brain in 60 seconds as opposed to normal water within 10 minutes.

System command keypad

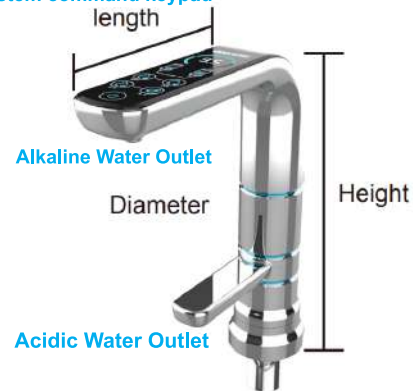

Size

1. length : 215mm
2. Height : 264mm
3. Diameter: 50mm

DIMENSIONS : 365 mm (W) * 360mm(H)*150mm

Power Supply : AC 200-240V ~ 50/60Hz

Energy Consumption : 300 W

Min / Max water Pressure: 1.5 - 5 bar

Min / Max Water Temperature: 5-40 C

Electrode 9 Platinum coated Titanium Plates

PH range 4 - 11

Minimum feed flow : 2 l / min

*The system is controlled by a touch sensor. It can work at the same time as the normal water tap. Rio offers a combination of high technology, stylish design and advanced computerized system, providing ease of operation and performance.

*The central unit is under the sink, not to occupy space on the kitchen surfaces, and contains 9 ionisation plates and a filter system in the two integrated cartridges. The filters treat your tap water by retaining chlorine and sediment while the high-power electrolysis chamber ionizes water, making it alkaline or acidic according to your preferences.

*Before installing the system, check the water quality (chemical and bacteriological) to be sure you feed water is potable .

*RIO is designed to be simple to use. It has two mobile valves, one that offers alkaline water and one that provides acidic water.

*When selecting a level of alkalinity, the top tap offers alkaline water and the bottom one provides acidic water, so it's very simple to collect both types of water!



Ultraviolet sterilization is safe and very effective. This process does not change the taste, smell and color of water, but only removes the risk of disease caused by microbial contamination, making the water safe for human consumption

When bacteria, viruses and other micro-organisms are exposed to UV radiation, they are destroyed, which means they no longer pose a threat to our health.

The irradiation power is given by UV intensity and exposure time.

Install an Expert Water sterilizer and you will have the safety of a pure microbiological water!

- Simple installation - Input-Output and 220V power supply;
- Modern and compact design;
- The body of the sterilizer is made of stainless steel;
- Sterilizers designed for both residential and industrial areas.





Tehnickal Data	Flow	UV Power Lamp	Input / Output connections	Pressure (min/max)	Max Temp	Dimensions
Model	(mc/h)	W	(inch)	(bar)	(°C)	(L x l x h)(cm)
EWUV 6	0,12	6	1/4"	8	4 - 50	
EWUV 55	2,8	55	3/4"	8	4 - 50	96.5 L X 6 Ø
EWUV 110	5,5	2 X 55	1"	8	4 - 50	96,5 L X 11Ø
EWUV 165	8	3 X 55	1,5"	8	4 - 50	96,5 L X 13.3 Ø
EWUV 220	11	4 X 55	1,5"	8	4 - 50	96,5 L X 16,8 Ø

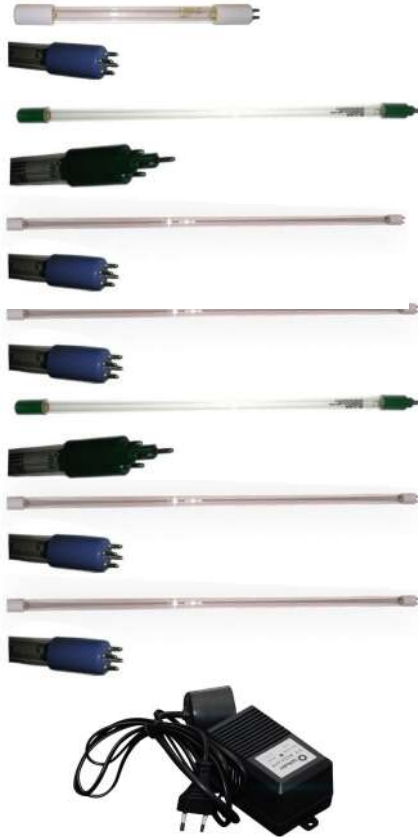

Article	Length (cm)	Diameter (cm)	Replace Hours
LAMP UV 6 W	22	1,7	3000
LAMP UV 25 W STERILIGHT	48	1,7	9000
LAMP UV 30 W	47	1,7	9000
LAMP UV 30 W	65	1,7	9000
LAMP UV 37 W STERILIGHT	83	1,7	9000
LAMP UV 40 W ETR	85	1,7	9000
LAMP UV 55 W ETR	93	1,7	9000
TRANSFORMER UV 40 W - 55 W			
TRANSFORMER UV 6 W			
CONTROLLER 55 W			

with counter of days for replacement

Expert Water®

**IMMA
CONCEPT**

...because water means life

Purifyo 